



TARGET
GLASS HARDWARE FACTORY

2023 CATALOGUE

We sell to more than 100 countries currently.
We are making our best effort to support our customers.
Where you are, there we are.

Sincerity | Respect | Kindness | Concentration | Perfection
真诚 | 尊重 | 善良 | 专注 | 完美

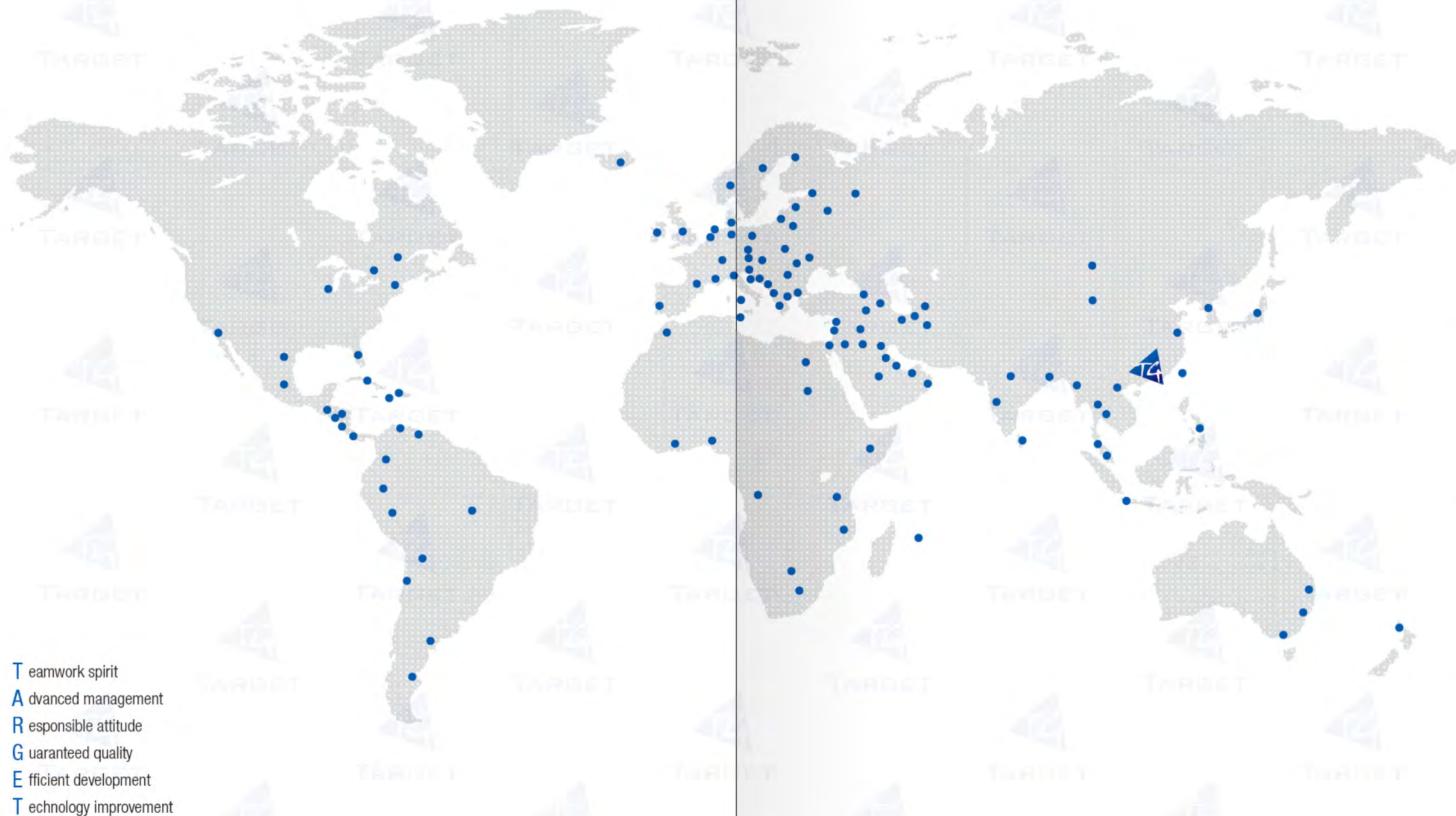

About TARGET

TARGET is one of the leading Glass Hardware Manufacturers in China. TARGET has been dedicated to excellent Glass Hardware and professional customer service for our customers all over the world.

TARGET is capable of offering both OEM and ODM services. Any drawings or samples for original design is welcome for developing customized products. For Proprietary Products, we can provide Patents Protection.

Sincerity | Respect | Kindness | Concentration | Perfection



TARGET is innovative and open to fulfill the requests of customers from various brands all over the world. We are using advanced production lines and innovative technologies to assure high quality. Meanwhile, we also make earnest endeavor to guarantee proper cost control and on time delivery.

TARGET is a company with strong social responsibility for being deeply concerned with the energy saving and environmental protection. We also show solicitude for our employees by continually improving their working and living conditions.

真诚 | 尊重 | 善良 | 专注 | 完美



Workshop

Since the factory was established, we have been implementing a strict quality management system. In strict accordance with the quality requirements of the factory for production and processing, at the same time to meet every detail of the customer requirements, and strive to achieve perfection.

More new and advanced machines are used in the workshop, which include laser cutting machine, laser welding machine, automatic feeding machine, automatic polishing machine and etc. All these machines can ease workers' labour intensity and bring us even high production efficiency. We get benefits from improved technology and offer customer better choices.

In order to further enhance the competitiveness, We decided to carry out lean production management in 2020. With lean production management rolling out inside the factory, we succeeded in reducing lead



time within the production system as well as response time from suppliers and to customers.

Implementation of the 5S on the production site which is central to lean manufacturing. It gives us a workplace that is clean, uncluttered and well organized. It helps to reduce waste and optimize productivity. More over, it helps us to standardize the on-site practices, keeping things safe and efficient.

Lean production management has improved the management level of our factory, made us more confident and strong, surpassing most of our competitors, and further implemented the sustainable development

We are creative and ready to embrace challenges. Tell us your idea, we will realize it.





Product

TARGET With years of experience in Frameless shower door and Architectural hardware fittings, we have developed the excellent fittings to simplify the installation of glass. Thanks to the clever design by our technology team, installation is quick and easy now. The reliability of our products allows installation to be a combination of quality and beauty. We always want you to be happy with the products you use for years.

Why Choose **TARGET**?

QUALITY

- 100% inspection before shipment
- Details oriented, capable to meet your project demand
- High quality surface finish. More attractive
- Extremely precise dimensions and accurate tolerance

COMPANY STRENGTH

- 17,800 Square meters in our own factory
- 1,000 Varieties of products and one-stop supply
- 250 Staff members handle your orders
- 104 Countries international sales network
- 25 Years Experience of Professional Hardware Production
- 24 Hours to respond by E-mail
- 5S Production management system

CERTIFICATE OF HONOR

- SGS Certificate from MADE IN CHINA
- Certificate of **TARGET** & TG BRAND

You are always welcome to **TARGET**!

Choose TARGET, Choose success!

Welcome To TARGET. Your Supplier And Specialist Of Glass Hardware With Fantastic Quality And Excellent Customer Service.

TARGET specializes in the production of glass hardware accessories. With our efforts and development, TARGET has become the leading glass hardware supplier from a small factory during last 20 years. We have experienced sales team. We are professional and passional to serve our customers around the world. We are always providing a quick and reliable service.

This catalogue provides general idea what products we can produce, not all of our products. We can produce different products according to your needs, (OEM or ODM services). If you cannot find what you want from the catalogue, please contact our sales or send an email to: info@hardware.hk.cn



General Index

Shower Door Hardware



012

PVC Seals Profile



107

Architectural Hardware



121

Handrails Fittings



189

Glass Door Hardware



211

Lever Handles & Accessories

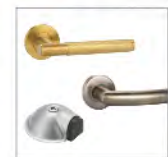

245

Spider Hardware



251



Internal View Of Shower Hinges



Heavy-duty hinges are available with square edges and bevel edges. Compare to popular standard shower hinges, heavy-duty shower hinges have the similar function but with bigger loading capacity. Heavy hinges offer good solution for wider and heavier glass doors that standard hinges can not support.

The hinge with two steel pins inside can meet two options of glass cut-outs: Mouse Ears and Square Corner cut-out. Heavy Duty Hinge let you provide an all-glass look shower door in an easy-to-install configuration. With four popular finishes, and attached pin.

Pin Rotates

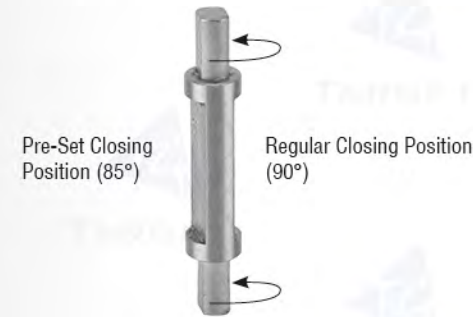

The standard pivot pins come with two sides. One side is marked at 90°. The other side is marked 85° which is available for off-angle installation.

Gasket Optional Kit for Hinges

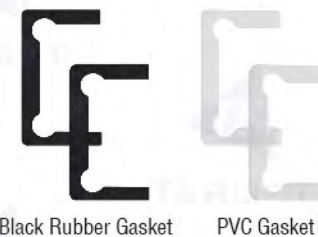

Technical Drawing

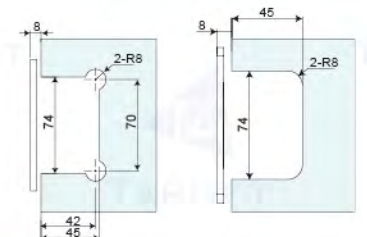

Shower Hinge Heavy Duty Series

Shower Hinge Heavy Duty Series



Art. No. SHT-BL
Glass to Wall T Shape 90° Shower Hinge



Material Brass
Finish Chrome / Brushed Nickel / Matte Black / Gold
Gasket Type PVC / Black Rubber / Asbestos

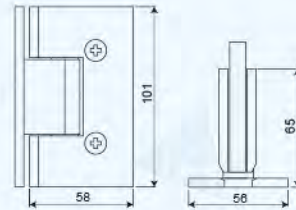

Art. No. SHT-BL-S
Glass to Wall 90° Shower Hinge with Short Plate



Material Brass
Finish Chrome / Brushed Nickel / Matte Black / Gold
Gasket Type PVC / Black Rubber / Asbestos

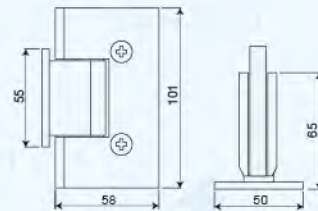

Art. No. SHT-BL-H
Glass to Wall 90° Shower Hinge with H plate



Material Brass
Finish Chrome / Brushed Nickel / Matte Black / Gold
Gasket Type PVC / Black Rubber / Asbestos

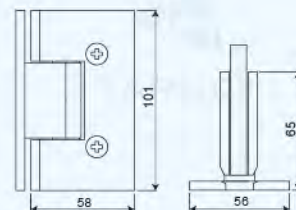

Shower Hinge Heavy Duty Series



Art. No. SH180-BL
Glass to Glass 180° Shower Hinge



Material Brass
Finish Chrome / Brushed Nickel / Matte Black / Gold
Gasket Type PVC / Black Rubber / Asbestos

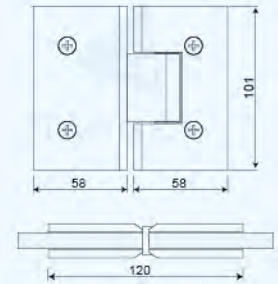

Art. No. SH135-BL
Glass to Glass 135° Shower Hinge



Material Brass
Finish Chrome / Brushed Nickel / Matte Black / Gold
Gasket Type PVC / Black Rubber / Asbestos

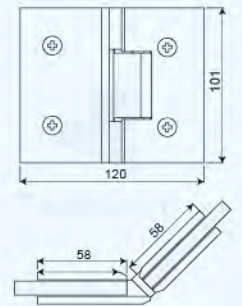

Art. No. SHL-BL
Glass to Glass 90° Shower Hinge



Material Brass
Finish Chrome / Brushed Nickel / Matte Black / Gold
Gasket Type PVC / Black Rubber / Asbestos

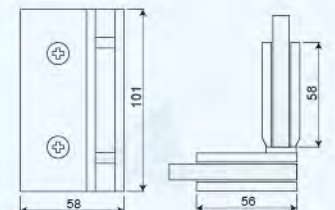

Shower Hinge Heavy Duty Series



Art. No. SHT-CL
Glass to Wall T Shape 90° Shower Hinge



Material Brass
Finish Chrome / Brushed Nickel / Matte Black / Gold
Gasket Type PVC / Black Rubber / Asbestos

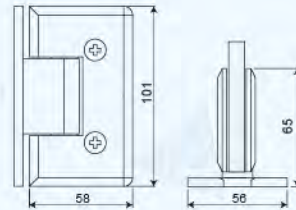

Art. No. SHT-CL-S
Glass to Wall 90° Shower Hinge with Short Plate



Material Brass
Finish Chrome / Brushed Nickel / Matte Black / Gold
Gasket Type PVC / Black Rubber / Asbestos

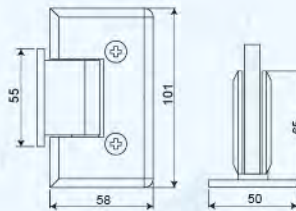

Art. No. SHT-CL-H
Glass to Wall 90° Shower Hinge with H plate



Material Brass
Finish Chrome / Brushed Nickel / Matte Black / Gold
Gasket Type PVC / Black Rubber / Asbestos

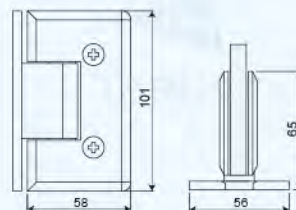

Shower Hinge Heavy Duty Series



Art. No. SH180-CL
Glass to Glass 180° Shower Hinge



Material Brass
Finish Chrome / Brushed Nickel / Matte Black / Gold
Gasket Type PVC / Black Rubber / Asbestos

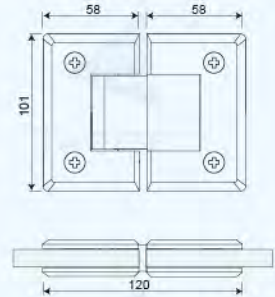

Art. No. SH135-CL
Glass to Glass 135° Shower Hinge



Material Brass
Finish Chrome / Brushed Nickel / Matte Black / Gold
Gasket Type PVC / Black Rubber / Asbestos

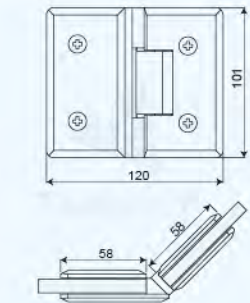

Art. No. SHL-CL
Glass to Glass 90° Shower Hinge



Material Brass
Finish Chrome / Brushed Nickel / Matte Black / Gold
Gasket Type PVC / Black Rubber / Asbestos

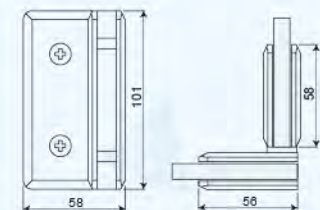

Ultra Slim Gap Shower Hinge

Ultra Slim Gap Shower hinges are made of solid brass, which have snap-on cover with invisible screws. The hinges are specially developed with ultra slim gap to offer stronger water proof ability than standard hinges.



- Ultra slim gap
- Snap-on covers for hidden screws
- Adjustable zero position $\pm 10^\circ$
- Self-closing from 15°

Specification

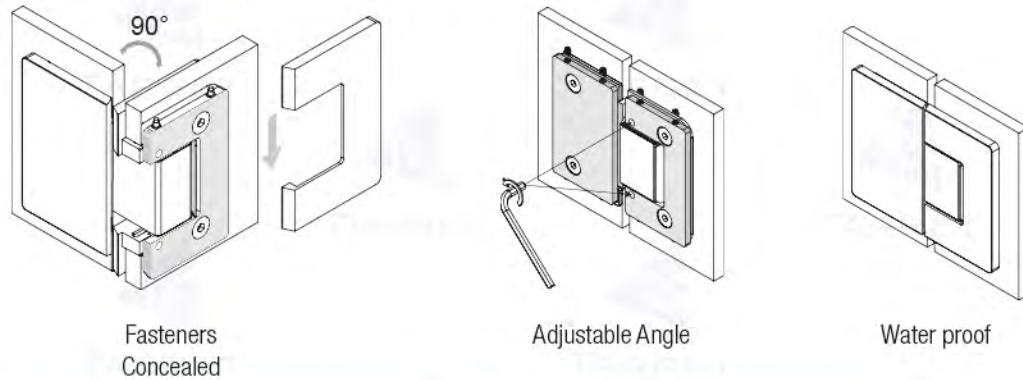

Technical Drawing

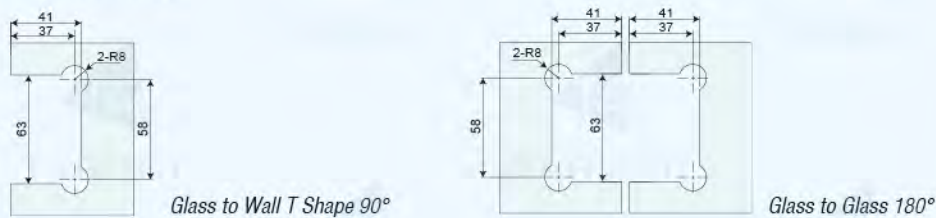

Ultra Slim Gap Shower Hinge

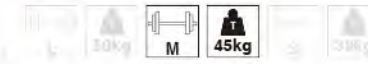

Art. No. SHT-A-ADC

Glass to Wall T Shape 90° Shower Hinge



Material Brass
Finish Chrome / Brushed Nickel / Matte Black / Gold
Gasket Type PVC / Black Rubber / Asbestos

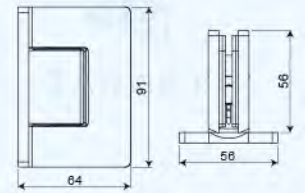

Art. No. SHT-A3-ADC

Glass to Wall L Shape 90° Shower Hinge



Material Brass
Finish Chrome / Brushed Nickel / Matte Black / Gold
Gasket Type PVC / Black Rubber / Asbestos

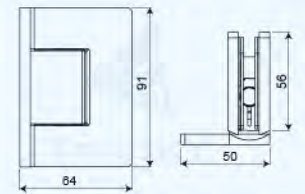

Art. No. SH180-A-ADC

Glass to Glass 180° Shower Hinge



Material Brass
Finish Chrome / Brushed Nickel / Matte Black / Gold
Gasket Type PVC / Black Rubber / Asbestos

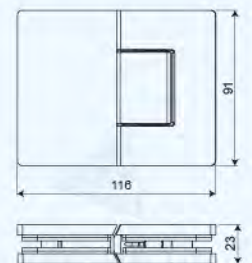

Adjustable Shower Hinge With Cover

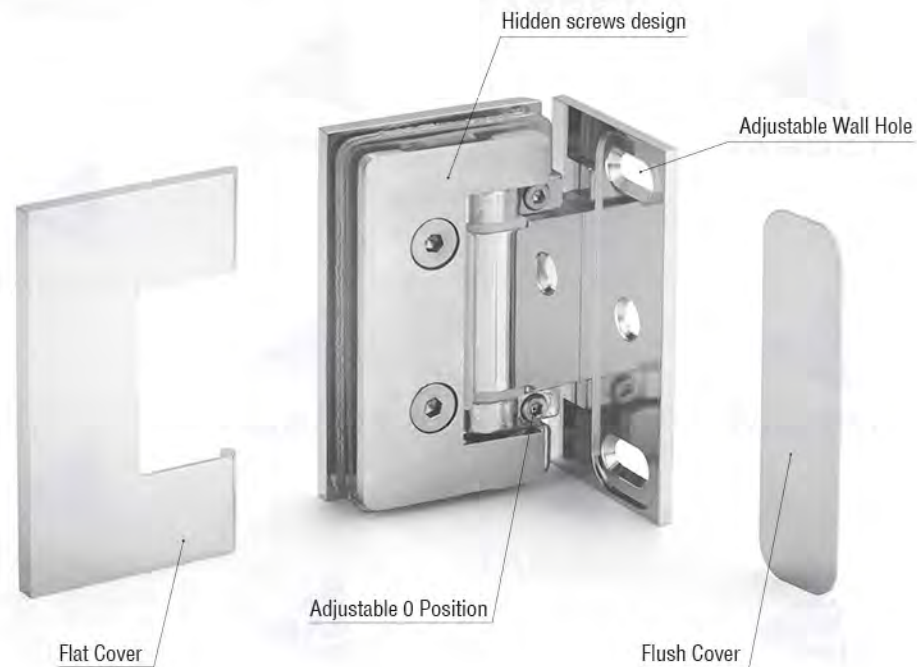

Our latest shower hinges help you realize a super stylish shower enclosure. Adjustable screw hole makes installation easier than ever before. Hidden screws design with stunning finish fits for any style of modern bathroom. All hardware has been tested for performance, strength and durability, providing smooth and steady door opening.



Art. No. SH180-B-CV
Glass to Glass 180° Shower Hinge



Material Brass
Finish Chrome / Brushed Nickel / Matte Black / Gold
Gasket Type PVC / Black Rubber / Asbestos

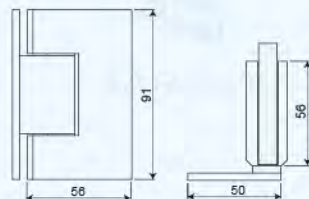

Adjustable Shower Hinge With Cover

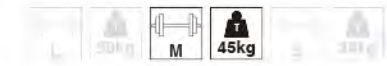

Art. No. SH135-B-CV
Glass to Glass 135° Shower Hinge



Material Brass
Finish Chrome / Brushed Nickel / Matte Black / Gold
Gasket Type PVC / Black Rubber / Asbestos

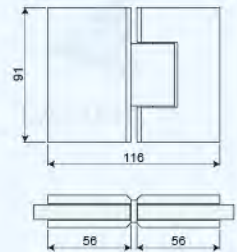

Art. No. SH135-B-CV
Glass to Glass 135° Shower Hinge



Material Brass
Finish Chrome / Brushed Nickel / Matte Black / Gold
Gasket Type PVC / Black Rubber / Asbestos

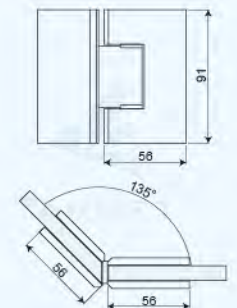

Art. No. SHL-B-CV
Glass To Glass 90° Shower Hinge



Material Brass
Finish Chrome / Brushed Nickel / Matte Black / Gold
Gasket Type PVC / Black Rubber / Asbestos

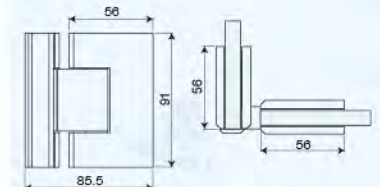

Adjustable Shower Hinge



Art. No. SHT-B-AD
Glass to Wall T Shape 90° Shower Hinge



Material Brass
Finish Chrome / Brushed Nickel / Matte Black / Gold
Gasket Type PVC / Black Rubber / Asbestos

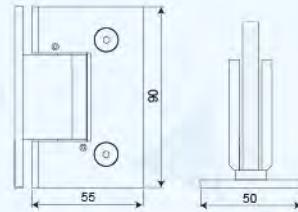

Art. No. SHT-B3-AD
Glass to Wall L Shape 90° Shower Hinge



Material Brass
Finish Chrome / Brushed Nickel / Matte Black / Gold
Gasket Type PVC / Black Rubber / Asbestos

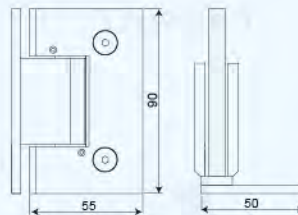

Art. No. SH135-B-AD
Glass to Glass 135° Shower Hinge



Material Brass
Finish Chrome / Brushed Nickel / Matte Black / Gold
Gasket Type PVC / Black Rubber / Asbestos

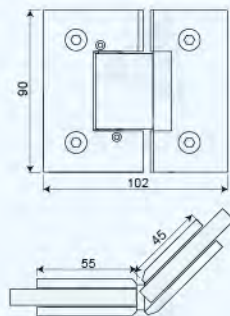

Adjustable Shower Hinge



Art. No. SH180-B-AD
Glass to Glass 180° Shower Hinge



Material Brass
Finish Chrome / Brushed Nickel / Matte Black / Gold
Gasket Type PVC / Black Rubber / Asbestos

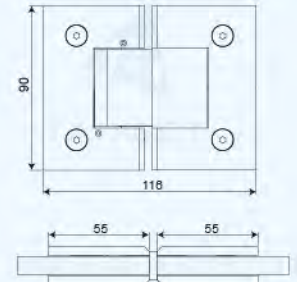

Art. No. SHT-C-AD
Glass to Wall T Shape 90° Shower Hinge



Material Brass
Finish Chrome / Brushed Nickel / Matte Black / Gold
Gasket Type PVC / Black Rubber / Asbestos

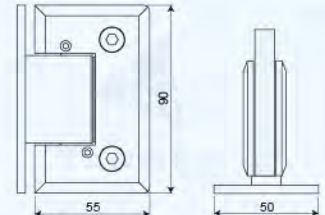

Art. No. SH180-C-AD
Glass to Glass 180° Shower Hinge



Material Brass
Finish Chrome / Brushed Nickel / Matte Black / Gold
Gasket Type PVC / Black Rubber / Asbestos

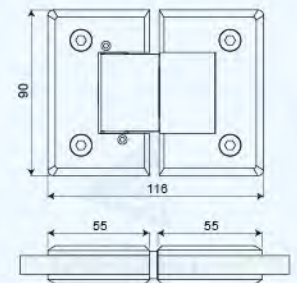



Shower Hinge Standard Duty Series

Shower Hinge Standard Duty Series



Art. No. SHT-A
Glass to Wall T Shape 90° Shower Hinge



Material Brass
Finish Chrome / Brushed Nickel / Matte Black / Gold
Gasket Type PVC / Black Rubber / Asbestos

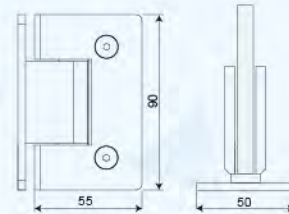

Art. No. SHT-A3
Glass to Wall L Shape 90° Shower Hinge



Material Brass
Finish Chrome / Brushed Nickel / Matte Black / Gold
Gasket Type PVC / Black Rubber / Asbestos

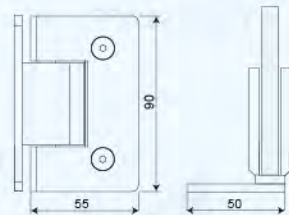

Art. No. SHT-A-S
Glass to Wall 90° Shower Hinge With Short Plate



Material Brass
Finish Chrome / Brushed Nickel / Matte Black / Gold
Gasket Type PVC / Black Rubber / Asbestos

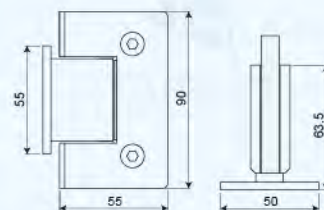

Shower Hinge Standard Duty Series



Art. No. SH180-A
Glass to Glass 180° Shower Hinge



Material Brass
Finish Chrome / Brushed Nickel / Matte Black / Gold
Gasket Type PVC / Black Rubber / Asbestos

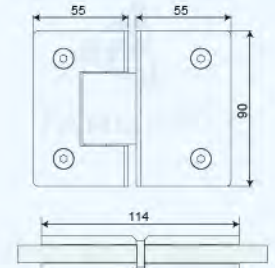

Art. No. SH135-A
Glass to Glass 135° Shower Hinge



Material Brass
Finish Chrome / Brushed Nickel / Matte Black / Gold
Gasket Type PVC / Black Rubber / Asbestos

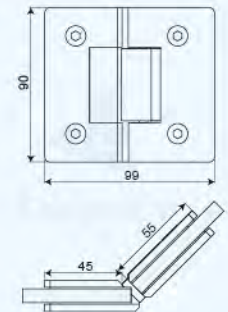

Art. No. SHL-A
Glass to Glass 90° Shower Hinge



Material Brass
Finish Chrome / Brushed Nickel / Matte Black / Gold
Gasket Type PVC / Black Rubber / Asbestos

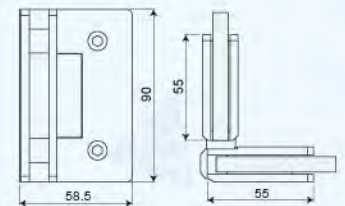

Shower Hinge Standard Duty Series



Art. No. SHT-B
Glass to Wall T Shape 90° Shower Hinge



Material Brass
Finish Chrome / Brushed Nickel / Matte Black / Gold
Gasket Type PVC / Black Rubber / Asbestos

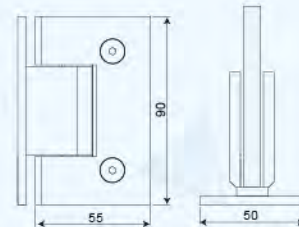

Art. No. SHT-B3
Glass to Wall L Shape 90° Shower Hinge



Material Brass
Finish Chrome / Brushed Nickel / Matte Black / Gold
Gasket Type PVC / Black Rubber / Asbestos

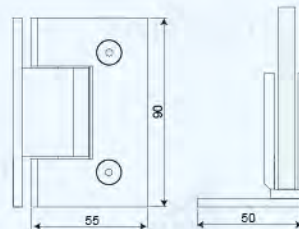

Art. No. SHT-B-S
Glass to Wall 90° Shower Hinge with Short plate



Material Brass
Finish Chrome / Brushed Nickel / Matte Black / Gold
Gasket Type PVC / Black Rubber / Asbestos

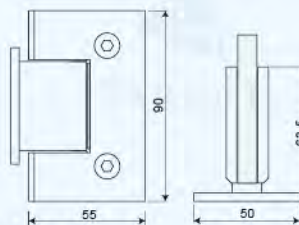

Shower Hinge Standard Duty Series



Art. No. SH180-B
Glass to Glass 180° Shower Hinge



Material Brass
Finish Chrome / Brushed Nickel / Matte Black / Gold
Gasket Type PVC / Black Rubber / Asbestos

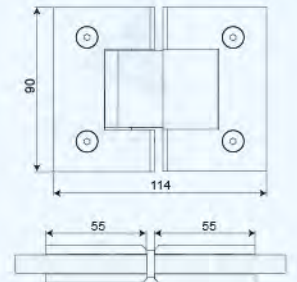

Art. No. SH135-B
Glass to Glass 135° Shower Hinge



Material Brass
Finish Chrome / Brushed Nickel / Matte Black / Gold
Gasket Type PVC / Black Rubber / Asbestos

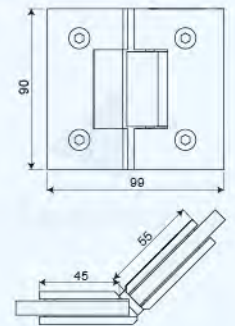

Art. No. SHL-B1
Glass to Glass 90° Shower Hinge



Material Brass
Finish Chrome / Brushed Nickel / Matte Black / Gold
Gasket Type PVC / Black Rubber / Asbestos

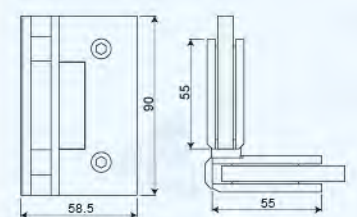

Shower Hinge Standard Duty Series

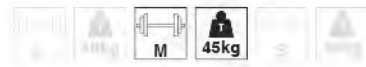

Art. No. SHT-C

Glass to Wall T Shape 90° Shower Hinge



Material Brass
Finish Chrome / Brushed Nickel / Matte Black / Gold
Gasket Type PVC / Black Rubber / Asbestos

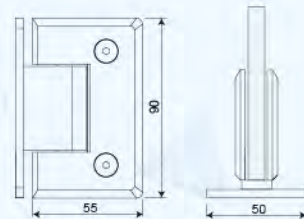

Art. No. SHT-C3

Glass to Wall L Shape 90° Shower Hinge



Material Brass
Finish Chrome / Brushed Nickel / Matte Black / Gold
Gasket Type PVC / Black Rubber / Asbestos

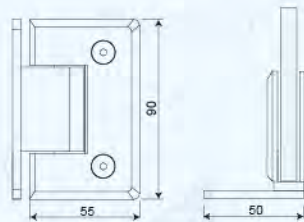

Art. No. SH135-C

Glass to Glass 135° Shower Hinge



Material Brass
Finish Chrome / Brushed Nickel / Matte Black / Gold
Gasket Type PVC / Black Rubber / Asbestos

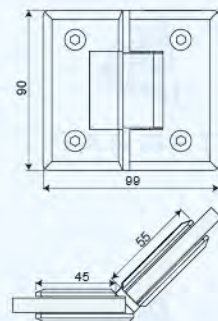

Shower Hinge Standard Duty Series



Art. No. SH180-C

Glass to Glass 180° Shower Hinge



Material Brass
Finish Chrome / Brushed Nickel / Matte Black / Gold
Gasket Type PVC / Black Rubber / Asbestos

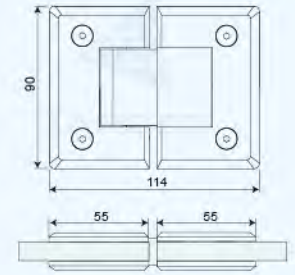

Art. No. SHL-C

Glass to Glass 90° Shower Hinge



Material Brass
Finish Chrome / Brushed Nickel / Matte Black / Gold
Gasket Type PVC / Black Rubber / Asbestos

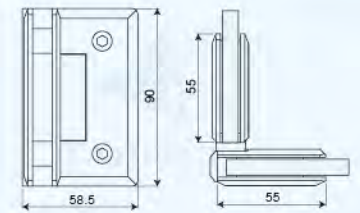

Art. No. SHL-C3

Glass to Glass Shower Hinge



Material Brass
Finish Chrome / Brushed Nickel / Matte Black / Gold
Gasket Type PVC / Black Rubber / Asbestos

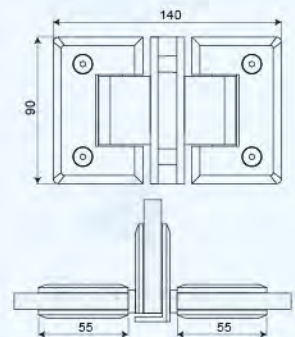

Shower Hinge Standard Duty Series

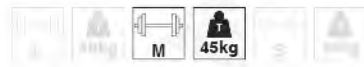

Art. No. SHT-D

Glass to Wall T Shape 90° Shower Hinge



Material Brass
Finish Chrome / Brushed Nickel / Matte Black / Gold
Gasket Type PVC / Black Rubber / Asbestos

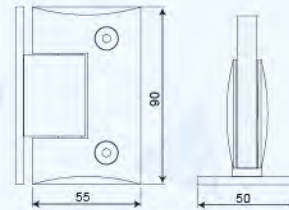

Art. No. SH135-D

Glass to Glass 135° Shower Hinge



Material Brass
Finish Chrome / Brushed Nickel / Matte Black / Gold
Gasket Type PVC / Black Rubber / Asbestos

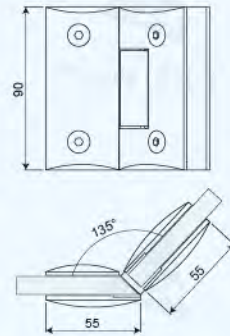

Art. No. SH180-D

Glass to Glass 180° Shower Hinge



Material Brass
Finish Chrome / Brushed Nickel / Matte Black / Gold
Gasket Type PVC / Black Rubber / Asbestos

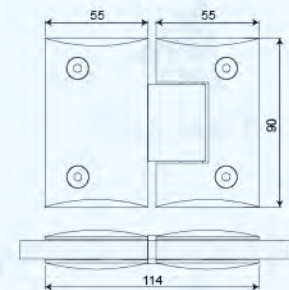

Shower Hinge Standard Duty Series



Art. No. SHL-D

Glass to Glass 90° Shower Hinge



Material Brass
Finish Chrome / Brushed Nickel / Matte Black / Gold
Gasket Type PVC / Black Rubber / Asbestos

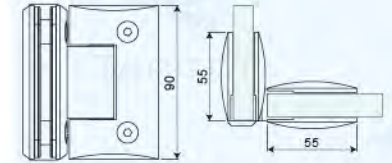

Art. No. SHT-E

Glass to Wall 90° Fixed Bracket



Material Brass
Finish Chrome / Brushed Nickel / Matte Black / Gold
Gasket Type PVC / Black Rubber / Asbestos

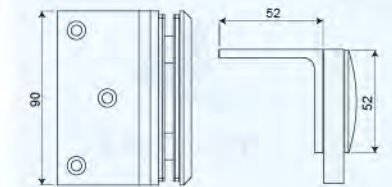

Art. No. SHL-E

Glass to Glass Double Sided 90° Fixed Bracket



Material Brass
Finish Chrome / Brushed Nickel / Matte Black / Gold
Gasket Type PVC / Black Rubber / Asbestos

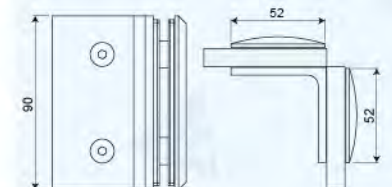

Shower Hinge ES1/ES2



Australian design. Manufactured according to the highest standard of fittings, which provides a slim and neat appearance so that the glass remains the central feature.

Art. No. SHT-B-SC

Glass to Wall T Shape 90° Shower Hinge



Material Brass
Finish Chrome / Brushed Nickel / Matte Black / Gold
Gasket Type PVC / Black Rubber / Asbestos

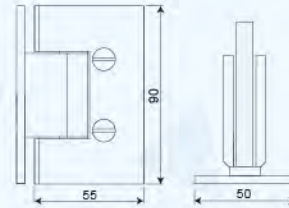

Art. No. SHT-B3-SC

Glass to Wall L Shape 90° Shower Hinge



Material Brass
Finish Chrome / Brushed Nickel / Matte Black / Gold
Gasket Type PVC / Black Rubber / Asbestos

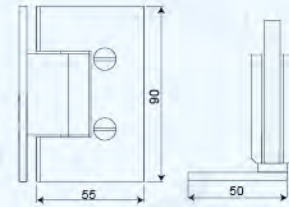

Art. No. SH180-B-SC

Glass to Glass 180° Shower Hinge



Material Brass
Finish Chrome / Brushed Nickel / Matte Black / Gold
Gasket Type PVC / Black Rubber / Asbestos

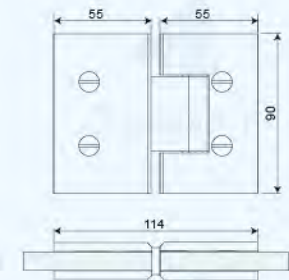

Shower Hinge ES1/ES2



Art. No. SH135-B-SC

Glass to Glass 135° Shower Hinge



Material Brass
Finish Chrome / Brushed Nickel / Matte Black / Gold
Gasket Type PVC / Black Rubber / Asbestos

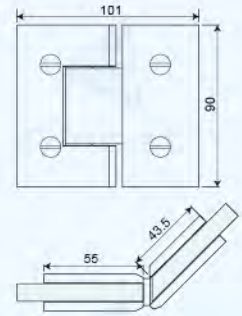

Art. No. SHL-B-SC

Glass to Glass 90° Shower Hinge



Material Brass
Finish Chrome / Brushed Nickel / Matte Black / Gold
Gasket Type PVC / Black Rubber / Asbestos

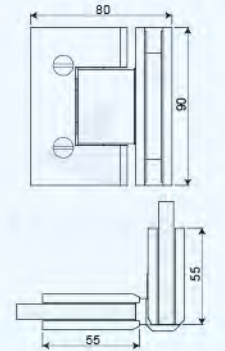

Technical Drawing

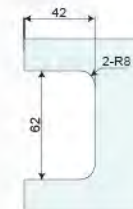

Glass to Wall T Shape 90°

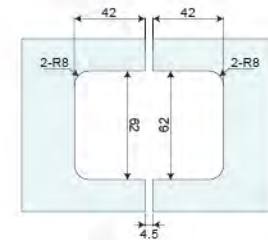

Glass to Glass 180°

Shower Hinge Standard Duty Series



Art. No. SHT-J

Glass to Wall T Shape 90° Shower Hinge



Material Brass
Finish Chrome / Brushed Nickel / Matte Black / Gold
Gasket Type PVC / Black Rubber / Asbestos

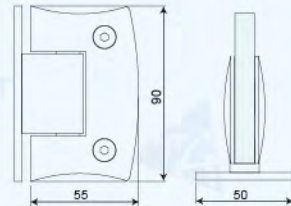

Art. No. SH180-J

Glass to Glass 180° Shower Hinge



Material Brass
Finish Chrome / Brushed Nickel / Matte Black / Gold
Gasket Type PVC / Black Rubber / Asbestos

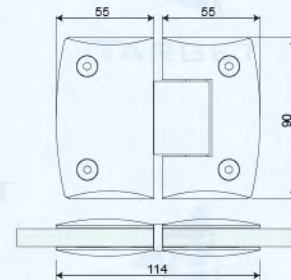

Art. No. SHL-J

Glass to Glass 90° Shower Hinge



Material Brass
Finish Chrome / Brushed Nickel / Matte Black / Gold
Gasket Type PVC / Black Rubber / Asbestos

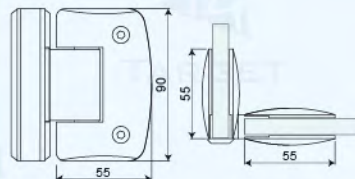

Shower Hinge Light Duty Series

Shower Hinge Light Duty Series



Square Edge



Art. No. SHT-BS

Glass to Wall T Shape 90° Shower Hinge



Material Brass
Finish Chrome / Brushed Nickel / Matte Black / Gold
Gasket Type PVC / Black Rubber / Asbestos

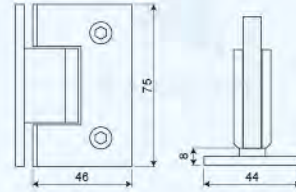

Art. No. SH180-BS

Glass to Glass 180° Shower Hinge



Material Brass
Finish Chrome / Brushed Nickel / Matte Black / Gold
Gasket Type PVC / Black Rubber / Asbestos

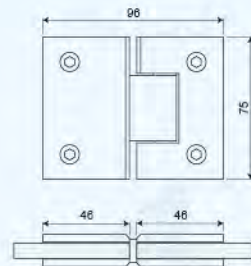

Art. No. SH135-BS

Glass to Glass 135° Shower Hinge



Material Brass
Finish Chrome / Brushed Nickel / Matte Black / Gold
Gasket Type PVC / Black Rubber / Asbestos

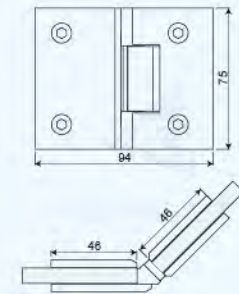

Art. No. SHL-BS

Glass to Glass 90° Shower Hinge



Material Brass
Finish Chrome / Brushed Nickel / Matte Black / Gold
Gasket Type PVC / Black Rubber / Asbestos

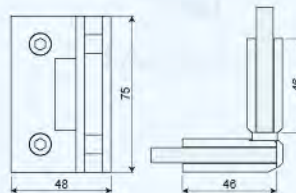

Shower Hinge Light Duty Series



Bevel Edge



Art. No. SHT-CS

Glass to Wall T Shape 90° Shower Hinge



Material Brass
Finish Chrome / Brushed Nickel / Matte Black / Gold
Gasket Type PVC / Black Rubber / Asbestos

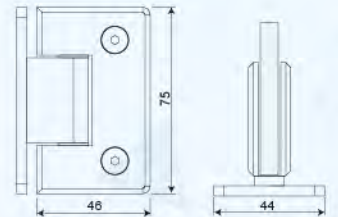

Art. No. SH180-CS

Glass to Glass 180° Shower Hinge



Material Brass
Finish Chrome / Brushed Nickel / Matte Black / Gold
Gasket Type PVC / Black Rubber / Asbestos

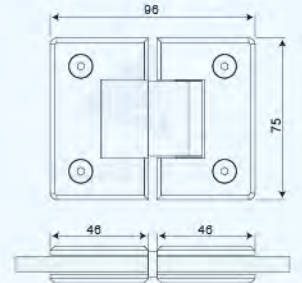

Art. No. SH135-CS

Glass to Glass 135° Shower Hinge



Material Brass
Finish Chrome / Brushed Nickel / Matte Black / Gold
Gasket Type PVC / Black Rubber / Asbestos

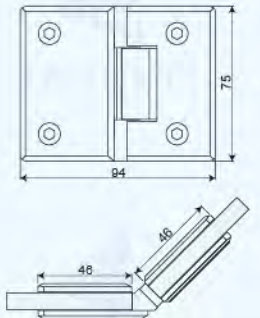

Art. No. SHL-CS

Glass to Glass 90° Shower Hinge



Material Brass
Finish Chrome / Brushed Nickel / Matte Black / Gold
Gasket Type PVC / Black Rubber / Asbestos

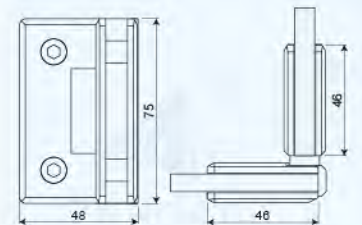

Top or Bottom Mount Pivot Shower Hinge



Technical Drawing

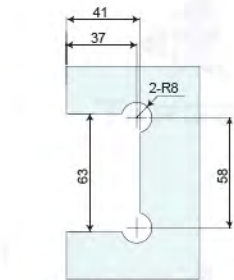

Top or Bottom Mount

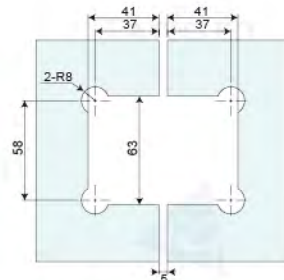

Glass-to-Fixed Transom Mount

Art. No. SH360-S
Top or Bottom Mount Pivot Hinge
Mouse Ears Cut-Out



Material Brass
Finish Chrome / Brushed Nickel / Matte Black / Gold
Gasket Type PVC / Black Rubber / Asbestos

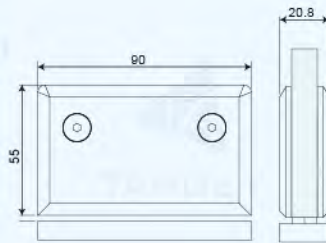

Art. No. SH360-S-G
Glass to Glass Pivot Hinge
Mouse Ears Cut-Out



Material Brass
Finish Chrome / Brushed Nickel / Matte Black / Gold
Gasket Type PVC / Black Rubber / Asbestos

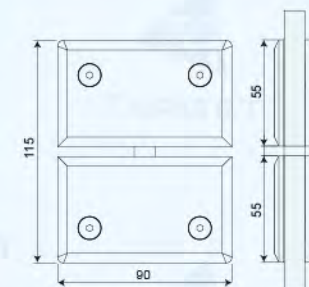

Top or Bottom Mount Pivot Shower Hinge

Art. No. SH360-B-C
Top or Bottom Mount Pivot Hinge
Square Corner Cut-Out



Material Brass
Finish Chrome / Brushed Nickel / Matte Black / Gold
Gasket Type PVC / Black Rubber / Asbestos

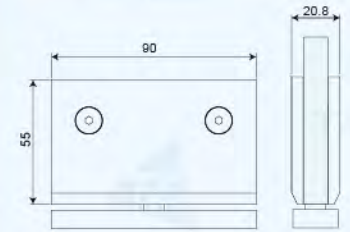

Art. No. SH360-S-C
Top or Bottom Mount Pivot Hinge
Square Corner Cut-Out



Material Brass
Finish Chrome / Brushed Nickel / Matte Black / Gold
Gasket Type PVC / Black Rubber / Asbestos

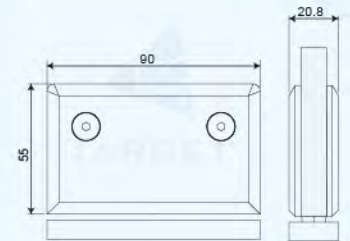

Art. No. SH360-S-G-C
Glass to Glass Pivot Hinge
Square Corner Cut-Out



Material Brass
Finish Chrome / Brushed Nickel / Matte Black / Gold
Gasket Type PVC / Black Rubber / Asbestos

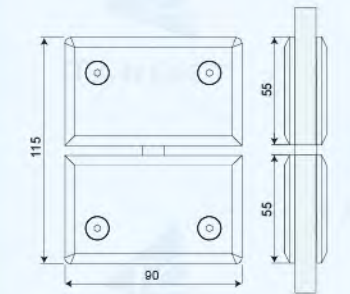

Technical Drawing

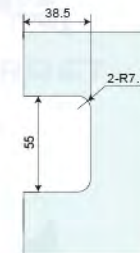

Top or Bottom Mount

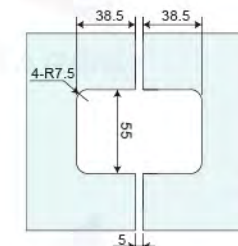

Glass-to-Fixed Transom Mount



Self Rising Shower Hinges

Self Rising Shower Hinge with Cover | Round Edge |

New



Art. No. SHL-U-L

Left Hand Wall Mount Offset Back Plate with cover

- 8-10mm
- 45kg
- 750mm
- Tempered Glass

Material | Brass
Finish | Chrome / Brushed Nickel /
 Matte Black / Gold

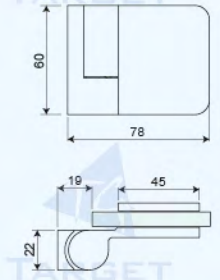

Art. No. SHL-U-R

Right Hand Wall Mount Offset Back Plate with cover

- 8-10mm
- 45kg
- 750mm
- Tempered Glass

Material | Brass
Finish | Chrome / Brushed Nickel /
 Matte Black / Gold

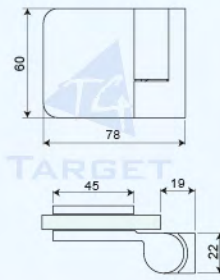

New



Art. No. SH180-U-L

Left Hand 180° Glass to Glass with cover

- 8-10mm
- 45kg
- 750mm
- Tempered Glass

Material | Brass
Finish | Chrome / Brushed Nickel /
 Matte Black / Gold

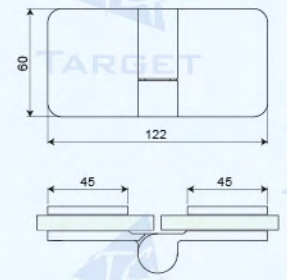

Art. No. SH180-U-R

Right Hand 180° Glass to Glass with cover

- 8-10mm
- 45kg
- 750mm
- Tempered Glass

Material | Brass
Finish | Chrome / Brushed Nickel /
 Matte Black / Gold

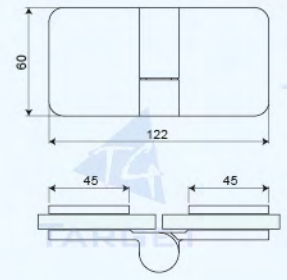

Self Rising Shower Hinge



Art. No. SHL-M-L
Left Hand Wall Mount Offset Back Plate

- 8-10mm
- 45kg
- 750mm
-

Material | Brass
Finish | Chrome / Brushed Nickel /
Matte Black / Gold

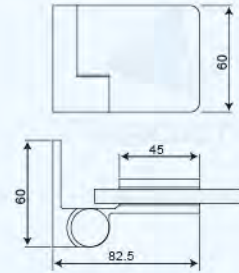

Art. No. SHL-M-R
Right Hand Wall Mount Offset Back Plate

- 8-10mm
- 45kg
- 750mm
-

Material | Brass
Finish | Chrome / Brushed Nickel /
Matte Black / Gold

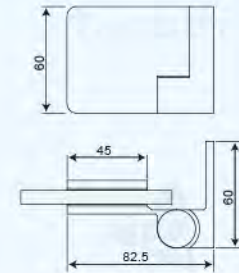

Art. No. SH180-M-L
Left Hand 180° Glass to Glass

- 8-10mm
- 45kg
- 750mm
-

Material | Brass
Finish | Chrome / Brushed Nickel /
Matte Black / Gold

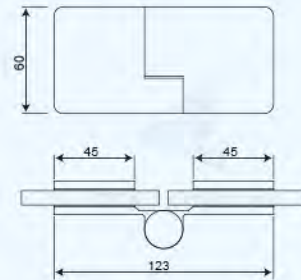

Art. No. SH180-M-R
Right Hand 180° Glass to Glass

- 8-10mm
- 45kg
- 750mm
-

Material | Brass
Finish | Chrome / Brushed Nickel /
Matte Black / Gold

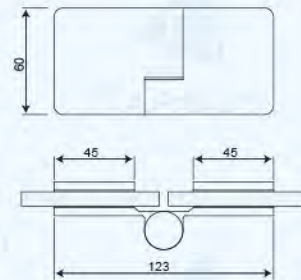

Self Rising Shower Hinge

| Square Edge |



Art. No. SHL-W-L
Left Hand Wall Mount Offset Back Plate

- 8-10mm
- 45kg
- 750mm
-

Material | Brass
Finish | Chrome / Brushed Nickel /
Matte Black / Gold

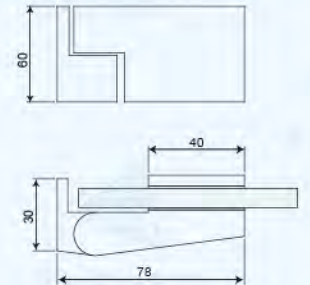

Art. No. SHL-W-R
Right Hand Wall Mount Offset Back Plate

- 8-10mm
- 45kg
- 750mm
-

Material | Brass
Finish | Chrome / Brushed Nickel /
Matte Black / Gold

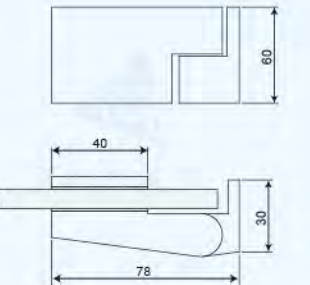

Art. No. SH180-W-L
Left Hand 180° Glass to Glass

- 8-10mm
- 45kg
- 750mm
-

Material | Brass
Finish | Chrome / Brushed Nickel /
Matte Black / Gold

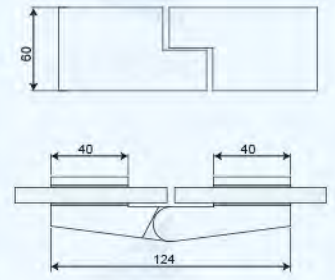

Art. No. SH180-W-R
Right Hand 180° Glass to Glass

- 8-10mm
- 45kg
- 750mm
-

Material | Brass
Finish | Chrome / Brushed Nickel /
Matte Black / Gold

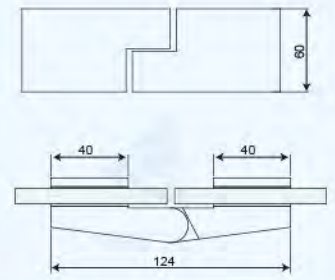

Rectangular Self Rising Hinge for flat head screw



Art. No. SHL-S-L
Left Hand Wall Mount Offset Back Plate



- 8-10mm
- 45kg
- 750mm
- Tempered Glass

Material | Brass
Finish | Chrome / Brushed Nickel /
Matte Black / Gold

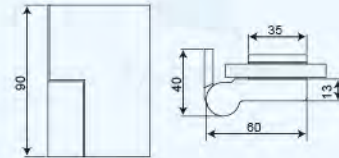

Art. No. SHL-S-R
Right Hand Wall Mount Offset Back Plate



- 8-10mm
- 45kg
- 750mm
- Tempered Glass

Material | Brass
Finish | Chrome / Brushed Nickel /
Matte Black / Gold

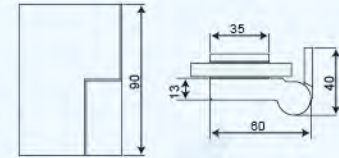

Art. No. SH180-S-L
Left Hand 180° Glass to Glass



- 8-10mm
- 45kg
- 750mm
- Tempered Glass

Material | Brass
Finish | Chrome / Brushed Nickel /
Matte Black / Gold

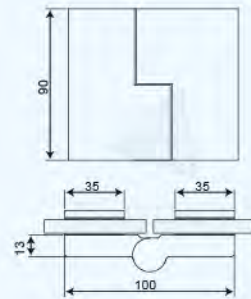

Art. No. SH180-S-R
Right Hand 180° Glass to Glass



- 8-10mm
- 45kg
- 750mm
- Tempered Glass

Material | Brass
Finish | Chrome / Brushed Nickel /
Matte Black / Gold

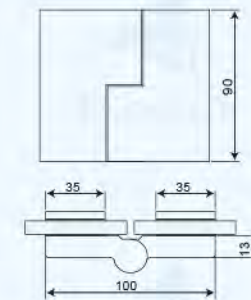

Rectangular Self Rising Hinge for countersunk screw



Art. No. SHL-Q-L
*Left Hand Wall Mount Offset Back Plate
Countersunk Holes Required*



- 8-10mm
- 45kg
- 750mm
- Tempered Glass

Material | Brass
Finish | Chrome / Brushed Nickel /
Matte Black / Gold

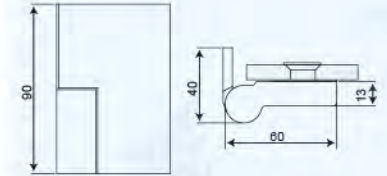

Art. No. SHL-Q-R
*Right Hand Wall Mount Offset Back Plate
Countersunk Holes Required*



- 8-10mm
- 45kg
- 750mm
- Tempered Glass

Material | Brass
Finish | Chrome / Brushed Nickel /
Matte Black / Gold

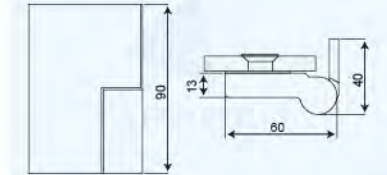

Art. No. SH180-Q-L
*Left Hand 180° Glass to Glass
Countersunk Holes Required*



- 8-10mm
- 45kg
- 750mm
- Tempered Glass

Material | Brass
Finish | Chrome / Brushed Nickel /
Matte Black / Gold

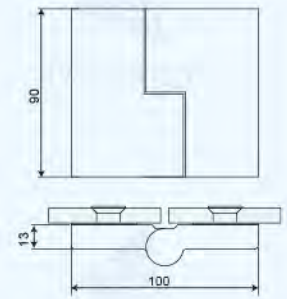

Art. No. SH180-Q-R
*Right Hand 180° Glass to Glass
Countersunk Holes Required*



- 8-10mm
- 45kg
- 750mm
- Tempered Glass

Material | Brass
Finish | Chrome / Brushed Nickel /
Matte Black / Gold

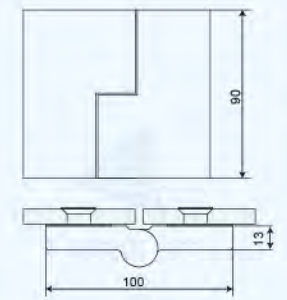

Square Free Swinging Hinge With Cover

New



Art. No. SH-S101
Bifold hinge glass to glass with cover

- Glass Thickness: 8-10mm
- Maximum Door Weight: 45kg
- Maximum Door Width: 750mm
- Tempered Glass

Material | Brass
Finish | Chrome / Brushed Nickel / Matte Black / Gold

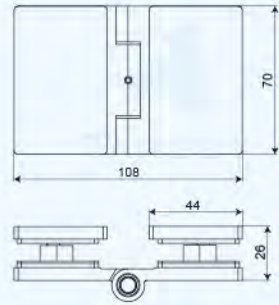

New



Art. No. SH-S102
Bifold hinge glass to wall with cover

- Glass Thickness: 8-10mm
- Maximum Door Weight: 45kg
- Maximum Door Width: 750mm
- Tempered Glass

Material | Brass
Finish | Chrome / Brushed Nickel / Matte Black / Gold

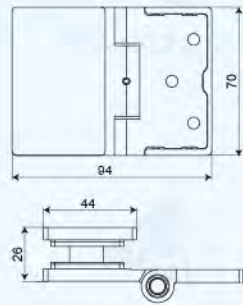

Art. No. SH-S21B
Bifold hinge glass to glass

- Glass Thickness: 8-10mm
- Maximum Door Weight: 45kg
- Maximum Door Width: 750mm
- Tempered Glass

Material | Brass
Finish | Chrome / Brushed Nickel / Matte Black / Gold

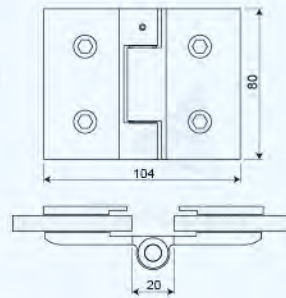

Art. No. SH-S18
Bifold hinge glass to glass

- Glass Thickness: 8-10mm
- Maximum Door Weight: 45kg
- Maximum Door Width: 750mm
- Tempered Glass

Material | Brass
Finish | Chrome / Brushed Nickel / Matte Black / Gold

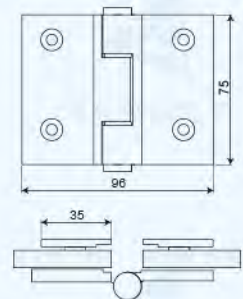

Free Swinging Hinge

New



Art. No. SH-S28
Bifold hinge glass to wall

- Glass Thickness: 8-10mm
- Maximum Door Weight: 30kg
- Maximum Door Width: 750mm
- Tempered Glass

Material | Brass
Finish | Chrome / Brushed Nickel / Matte Black / Gold

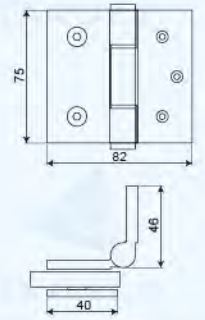

Art. No. SH-S30
Bifold hinge glass to glass

- Glass Thickness: 8-10mm
- Maximum Door Weight: 30kg
- Maximum Door Width: 750mm
- Tempered Glass

Material | Brass
Finish | Chrome / Brushed Nickel / Matte Black / Gold

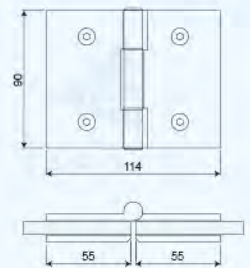

Art. No. SH-P1
180° Glass to Glass Hinge

- Glass Thickness: 8mm
- Maximum Door Weight: 30kg
- Maximum Door Width: 750mm
- Tempered Glass

Material | Brass
Finish | Chrome / Brushed Nickel / Matte Black / Gold

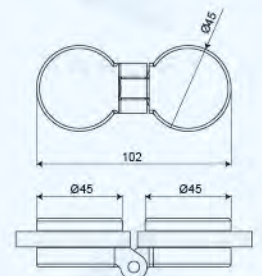

Art. No. SH-P2
Glass to wall hinge

- Glass Thickness: 8mm
- Maximum Door Weight: 30kg
- Maximum Door Width: 750mm
- Tempered Glass

Material | Brass
Finish | Chrome / Brushed Nickel / Matte Black / Gold

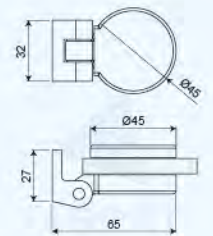

Free Swinging Hinge

Art. No. SH-H90
Cabinet glass to wall hinge

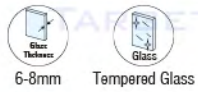

Material Brass
Finish Chrome / Brushed Nickel /
Matte Black

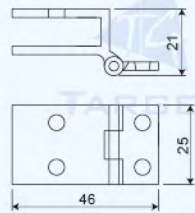

Art. No. SH-H02
Cabinet glass to glass hinge

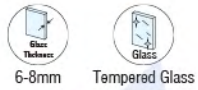

Material Brass
Finish Chrome / Brushed Nickel /
Matte Black

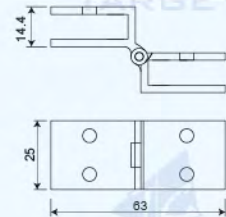

Art. No. SH-B90
Glass to wall hinge



Material Brass
Finish Chrome / Brushed Nickel /
Matte Black

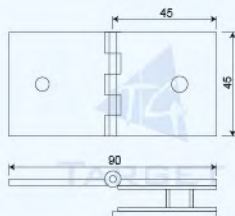

Art. No. SH-B180
Glass to glass hinge

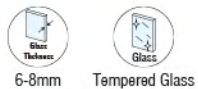

Material Brass
Finish Chrome / Brushed Nickel /
Matte Black

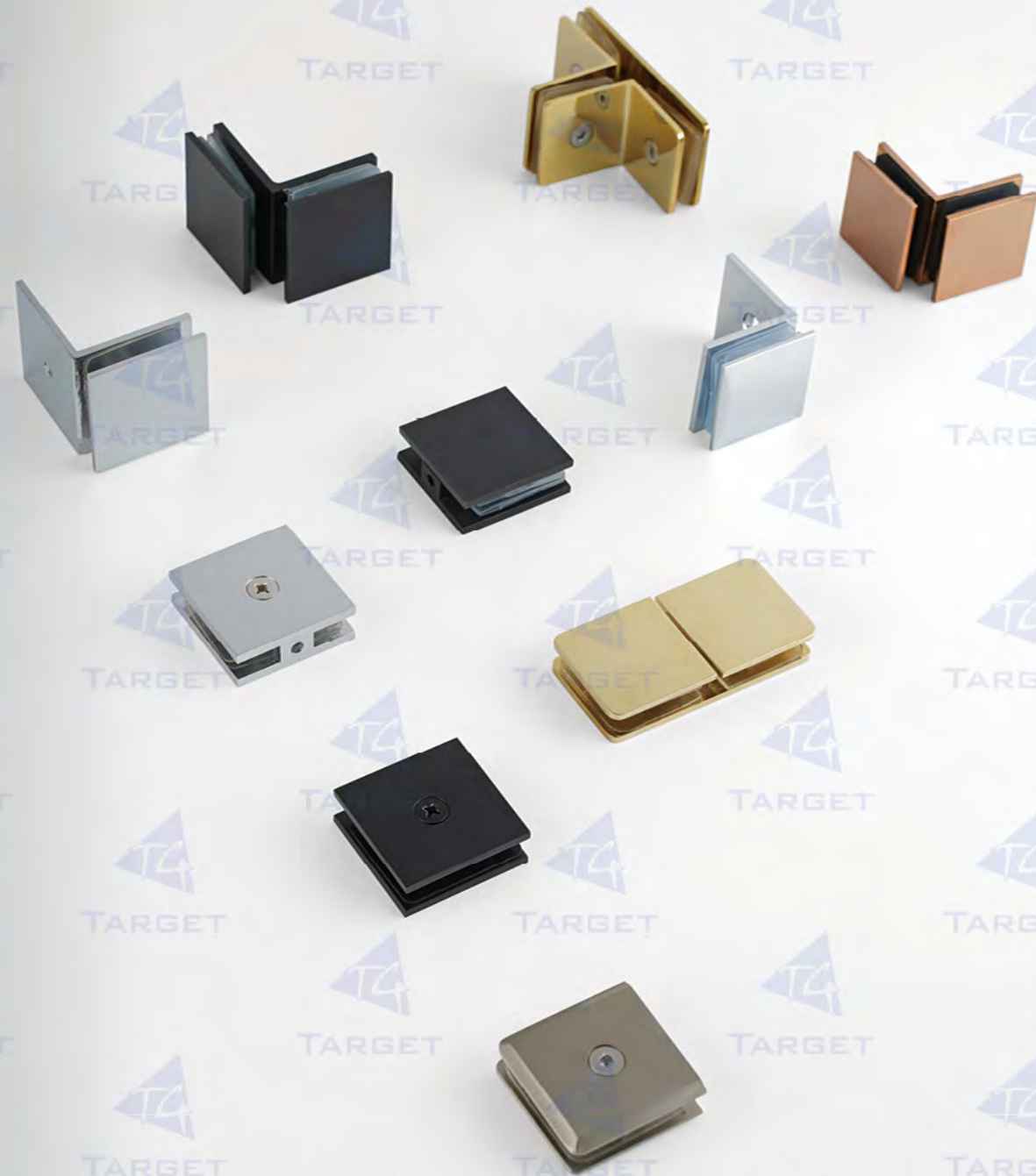
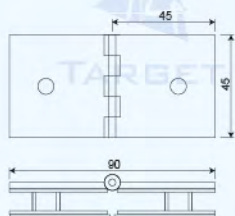

Fixed Bracket Standard Series

Fixed Bracket Standard Series



Art. No. GC00-A1
Glass to Wall 90° Fixed Bracket

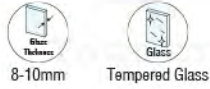

Material Brass
Finish Chrome / Brushed Nickel / Matte Black / Gold
Gasket Type PVC / Black Rubber / Asbestos

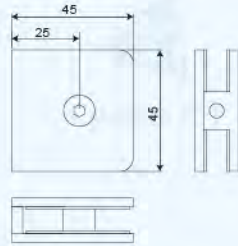

Art. No. GC00-A
Glass to Wall 90° Fixed Bracket

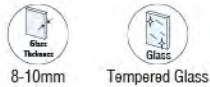

Material Brass
Finish Chrome / Brushed Nickel / Matte Black / Gold
Gasket Type PVC / Black Rubber / Asbestos

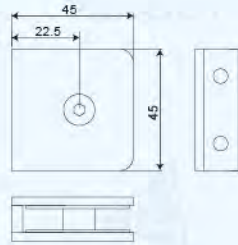

Art. No. GC90-A1
Glass to Wall 90° Fixed Bracket

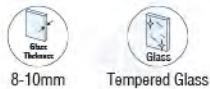

Material Brass
Finish Chrome / Brushed Nickel / Matte Black / Gold
Gasket Type PVC / Black Rubber / Asbestos

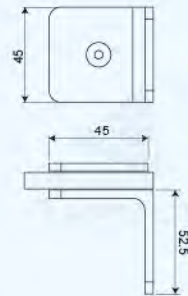

Art. No. GC90-A2
Glass to Glass Double Sided 90° Fixed Bracket

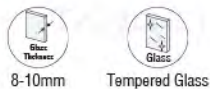

Material Brass
Finish Chrome / Brushed Nickel / Matte Black / Gold
Gasket Type PVC / Black Rubber / Asbestos

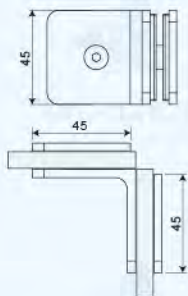

Fixed Bracket Standard Series



Art. No. GC135-A2
Glass to Glass Double Sided 135° Fixed Bracket



Material Brass
Finish Chrome / Brushed Nickel / Matte Black / Gold
Gasket Type PVC / Black Rubber / Asbestos

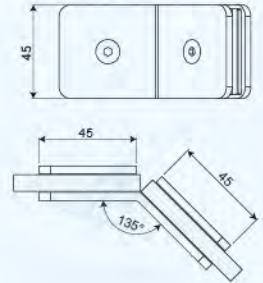

Art. No. GC180-A1
Glass to Wall 180° Fixed Bracket



Material Brass
Finish Chrome / Brushed Nickel / Matte Black / Gold
Gasket Type PVC / Black Rubber / Asbestos

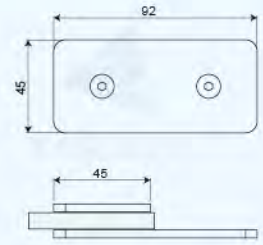

Art. No. GC180-A2
Glass to Glass Double Sided 180° Fixed Bracket



Material Brass
Finish Chrome / Brushed Nickel / Matte Black / Gold
Gasket Type PVC / Black Rubber / Asbestos

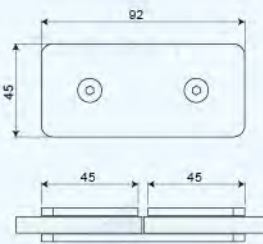

Art. No. GC90-A3
Fix Bracket



Material Brass
Finish Chrome / Brushed Nickel / Matte Black / Gold
Gasket Type PVC / Black Rubber / Asbestos

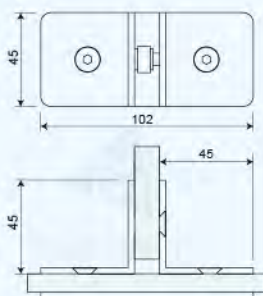

Fixed Bracket Standard Series



Art. No. GC00-B1
Glass to Wall 90° Fixed Bracket



Material | Brass
Finish | Chrome / Brushed Nickel /
Matte Black / Gold
Gasket Type | PVC / Black Rubber / Asbestos

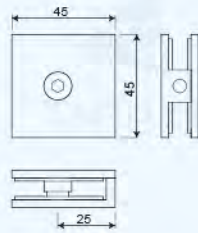

Art. No. GC00-B
Glass to Wall 90° Fixed Bracket

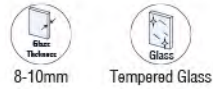

Material | Brass
Finish | Chrome / Brushed Nickel /
Matte Black / Gold
Gasket Type | PVC / Black Rubber / Asbestos



Art. No. GC90-B1
Glass to Wall 90° Fixed Bracket

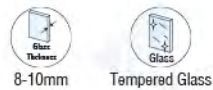

Material | Brass
Finish | Chrome / Brushed Nickel /
Matte Black / Gold
Gasket Type | PVC / Black Rubber / Asbestos

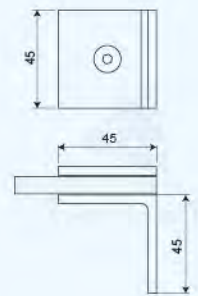

Art. No. GC90-B2
Glass to Glass Double Sided 90° Fixed Bracket

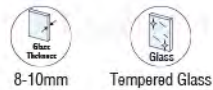

Material | Brass
Finish | Chrome / Brushed Nickel /
Matte Black / Gold
Gasket Type | PVC / Black Rubber / Asbestos

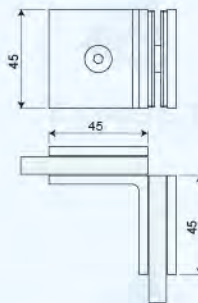

Fixed Bracket Standard Series



Art. No. GC135-B2
Glass to Glass Double Sided 135° Fixed Bracket



Material | Brass
Finish | Chrome / Brushed Nickel /
Matte Black / Gold
Gasket Type | PVC / Black Rubber / Asbestos

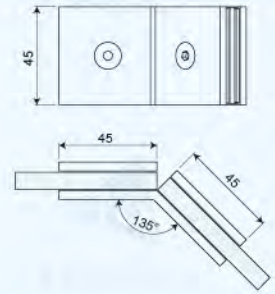

Art. No. GC180-B1
Glass to Wall 180° Fixed Bracket



Material | Brass
Finish | Chrome / Brushed Nickel /
Matte Black / Gold
Gasket Type | PVC / Black Rubber / Asbestos

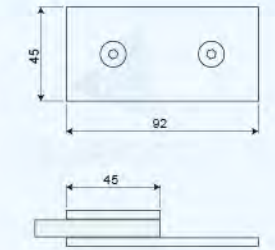

Art. No. GC180-B2
Glass to Glass Double Sided 180° Fixed Bracket

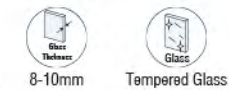

Material | Brass
Finish | Chrome / Brushed Nickel /
Matte Black / Gold
Gasket Type | PVC / Black Rubber / Asbestos

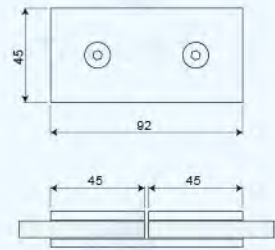

Fixed Bracket Standard series



Art. No. GC00-C1
Glass to Wall 90° Fixed Bracket



Material Brass
Finish Chrome / Brushed Nickel /
Matte Black / Gold
Gasket Type PVC / Black Rubber / Asbestos

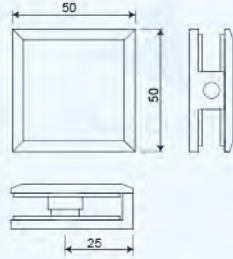

Art. No. GC00-C2
Glass to Wall 90° Fixed Bracket

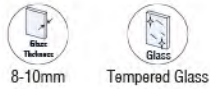

Material Brass
Finish Chrome / Brushed Nickel /
Matte Black / Gold
Gasket Type PVC / Black Rubber / Asbestos

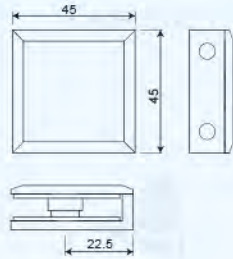

Art. No. GC90-C1
Glass to Wall 90° Fixed Bracket

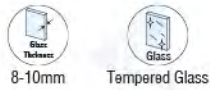

Material Brass
Finish Chrome / Brushed Nickel /
Matte Black / Gold
Gasket Type PVC / Black Rubber / Asbestos

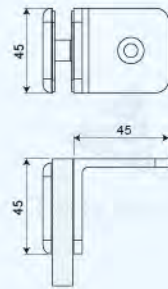

Art. No. GC90-C2
Glass to Glass Double Sided 90° Fixed Bracket

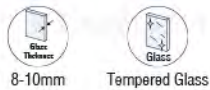

Material Brass
Finish Chrome / Brushed Nickel /
Matte Black / Gold
Gasket Type PVC / Black Rubber / Asbestos

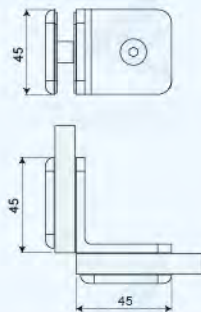

Fixed Bracket Standard series



Art. No. GC135-C2
Glass to Glass Double Sided 135° Fixed Bracket



Material Brass
Finish Chrome / Brushed Nickel /
Matte Black / Gold
Gasket Type PVC / Black Rubber / Asbestos

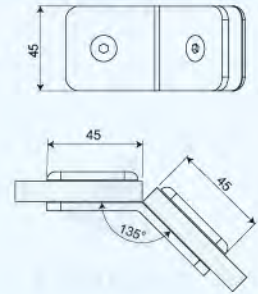

Art. No. GC180-C1
Glass to Wall 180° Fixed Bracket



Material Brass
Finish Chrome / Brushed Nickel /
Matte Black / Gold
Gasket Type PVC / Black Rubber / Asbestos

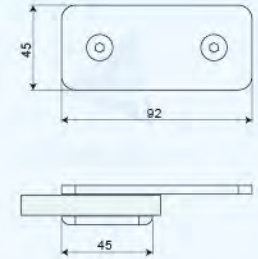

Art. No. GC180-C2
Glass to Glass Double Sided 180° Fixed Bracket



Material Brass
Finish Chrome / Brushed Nickel /
Matte Black / Gold
Gasket Type PVC / Black Rubber / Asbestos

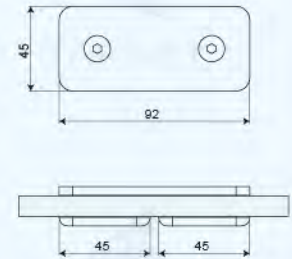

Fixed Bracket Standard series



Art. No. GC00-D1
Glass to Wall 90° Fixed Bracket



Material | Brass
Finish | Chrome / Brushed Nickel /
Matte Black / Gold
Gasket Type | PVC / Black Rubber / Asbestos

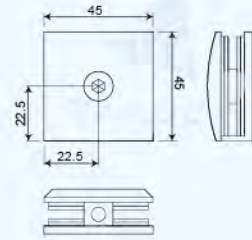

Art. No. GC00-D2
Glass to Wall 90° Fixed Bracket

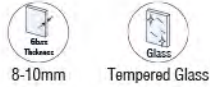

Material | Brass
Finish | Chrome / Brushed Nickel /
Matte Black / Gold
Gasket Type | PVC / Black Rubber / Asbestos

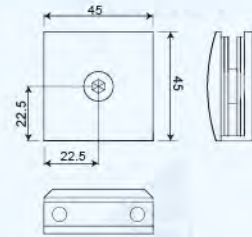

Art. No. GC90-D1
Glass to Wall 90° Fixed Bracket

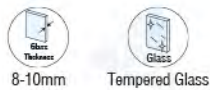

Material | Brass
Finish | Chrome / Brushed Nickel /
Matte Black / Gold
Gasket Type | PVC / Black Rubber / Asbestos

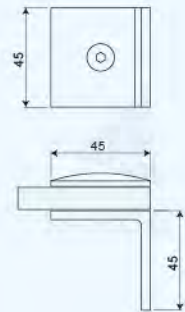

Art. No. GC90-D2
Glass to Glass Double Sided 90° Fixed Bracket

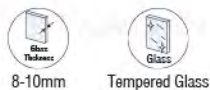

Material | Brass
Finish | Chrome / Brushed Nickel /
Matte Black / Gold
Gasket Type | PVC / Black Rubber / Asbestos

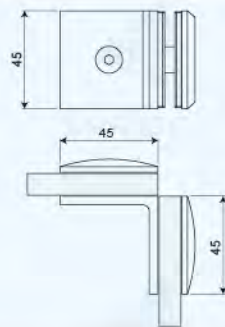

Fixed Bracket Standard series



Art. No. GC135-D2
Glass to Glass Double Sided 135° Fixed Bracket



Material | Brass
Finish | Chrome / Brushed Nickel /
Matte Black / Gold
Gasket Type | PVC / Black Rubber / Asbestos

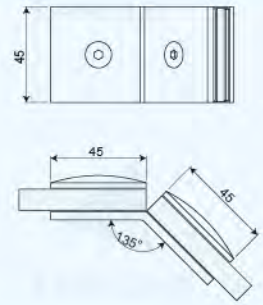

Art. No. GC180-D1
Glass to Wall 180° Fixed Bracket



Material | Brass
Finish | Chrome / Brushed Nickel /
Matte Black / Gold
Gasket Type | PVC / Black Rubber / Asbestos

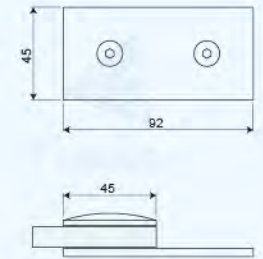

Art. No. GC180-D2
Glass to Glass Double Sided 180° Fixed Bracket

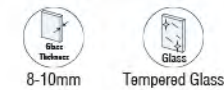

Material | Brass
Finish | Chrome / Brushed Nickel /
Matte Black / Gold
Gasket Type | PVC / Black Rubber / Asbestos

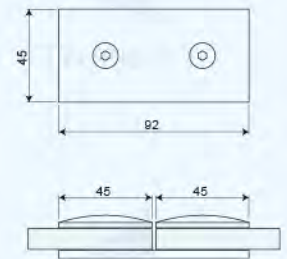

Spider Hinge VY80 series

| Stainless Steel |



Art. No. VY80-2-A

Wall to glass hinge *(With spring and stop at 90°)*

Material	SUS304 / SUS316
Finish	Polished / Satin / Matte Black
Max Capacities	30kgs

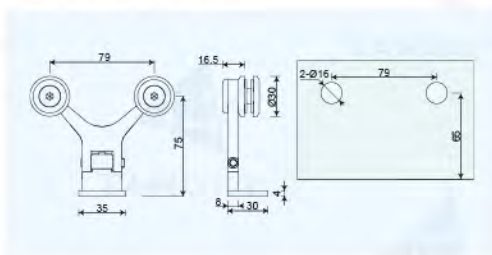

Art. No. VY80-4-A

Glass to glass hinge *(With spring and stop at 90°)*

Material	SUS304 / SUS316
Finish	Polished / Satin / Matte Black
Max Capacities	30kgs

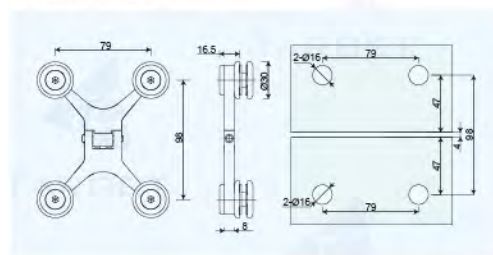

Spider Hinge VY80 series



Art. No. VY80-0

Wall to glass connector

Material	SUS304 / SUS316
Finish	Polished / Satin / Matte Black
Max Capacities	30kgs

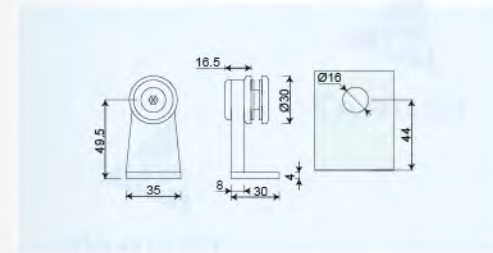

Art. No. VY80-1

Wall to glass hinge

Material	SUS304 / SUS316
Finish	Polished / Satin / Matte Black
Max Capacities	30kgs

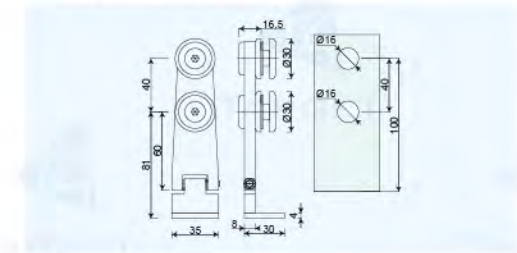

Art. No. VY80-2

Wall to glass hinge

Material	SUS304 / SUS316
Finish	Polished / Satin / Matte Black
Max Capacities	30kgs

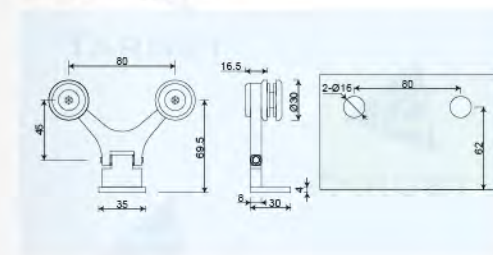

Art. No. VY80-4

Glass to glass hinge

Material	SUS304 / SUS316
Finish	Polished / Satin / Matte Black
Max Capacities	30kgs

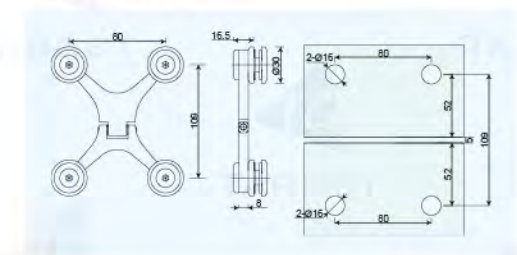

**Stainless Steel Shower Hinge
Standard Series**



Art. No. SHT-A-ST

Glass to Wall T Shape 90° Shower Hinge

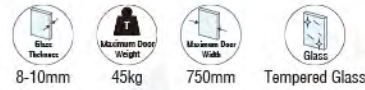

Material SUS304 / SUS316
Finish Polished / Satin / Matte Black / Gold
Gasket Type PVC / Black Rubber / Asbestos

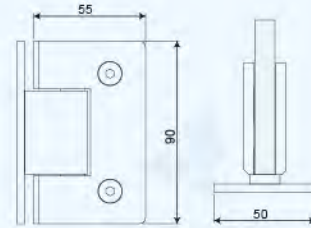

Art. No. SHT-A3-ST

Glass to Wall L Shape 90° Shower Hinge



Material SUS304 / SUS316
Finish Polished / Satin / Matte Black / Gold
Gasket Type PVC / Black Rubber / Asbestos

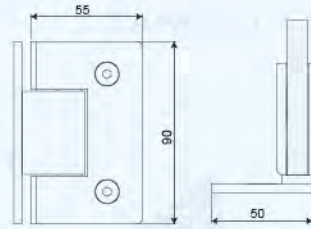

Art. No. SH135-A-ST

Glass to Glass 135° Shower Hinge



Material SUS304 / SUS316
Finish Polished / Satin / Matte Black / Gold
Gasket Type PVC / Black Rubber / Asbestos

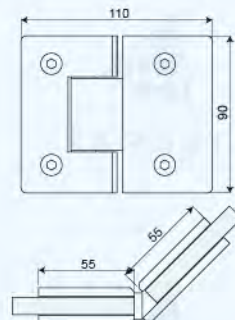

**Stainless Steel Shower Hinge
Standard Series**



Art. No. SH180-A-ST

Glass to Glass 180° Shower Hinge



Material SUS304 / SUS316
Finish Polished / Satin / Matte Black / Gold
Gasket Type PVC / Black Rubber / Asbestos

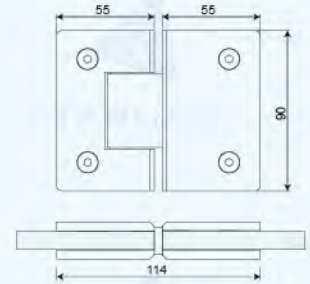

Art. No. SHL-A1-ST

Glass to Glass 90° Shower Hinge



Material SUS304 / SUS316
Finish Polished / Satin / Matte Black / Gold
Gasket Type PVC / Black Rubber / Asbestos

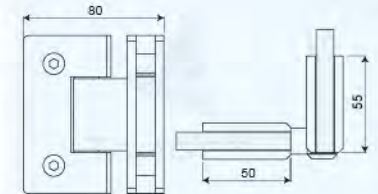

Art. No. SHL-A3-ST

Glass to Glass 90° Shower Hinge



Material SUS304 / SUS316
Finish Polished / Satin / Matte Black / Gold
Gasket Type PVC / Black Rubber / Asbestos

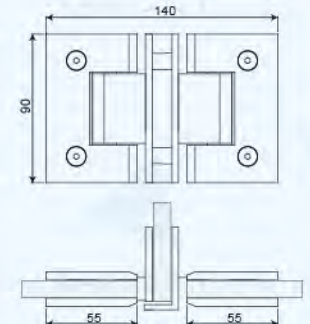

**Stainless Steel Shower Hinge
Standard Series**



Art. No. SHT-B-ST

Glass to Wall T Shape 90° Shower Hinge



Material SUS304 / SUS316
Finish Polished / Satin / Matte Black / Gold
Gasket Type PVC / Black Rubber / Asbestos

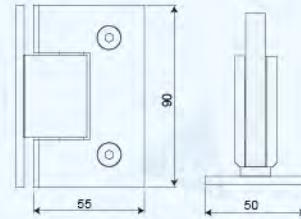

Art. No. SHT-B3-ST

Glass to Wall L Shape 90° Shower Hinge



Material SUS304 / SUS316
Finish Polished / Satin / Matte Black / Gold
Gasket Type PVC / Black Rubber / Asbestos

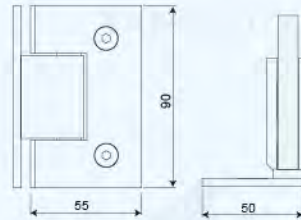

Art. No. SH135-B-ST

Glass to Glass 135° Shower Hinge



Material SUS304 / SUS316
Finish Polished / Satin / Matte Black / Gold
Gasket Type PVC / Black Rubber / Asbestos

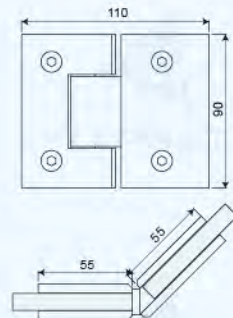

**Stainless Steel Shower Hinge
Standard Series**



Art. No. SH180-B-ST

Glass to Glass 180° Shower Hinge



Material SUS304 / SUS316
Finish Polished / Satin / Matte Black / Gold
Gasket Type PVC / Black Rubber / Asbestos

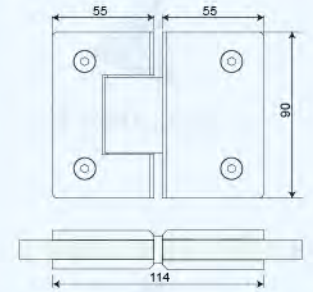

Art. No. SHL-B1-ST

Glass to Glass 90° Shower Hinge



Material SUS304 / SUS316
Finish Polished / Satin / Matte Black / Gold
Gasket Type PVC / Black Rubber / Asbestos

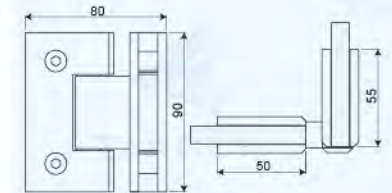

Art. No. SHO-B-ST

Glass to Wall Fix Bracket



Material SUS304 / SUS316
Finish Polished / Satin / Matte Black / Gold
Gasket Type PVC / Black Rubber / Asbestos

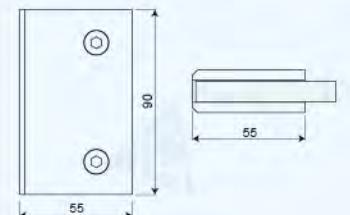

Stainless Steel Shower Hinge Standard Series



Art. No. SHT-C-ST

Glass to Wall T Shape 90° Shower Hinge



Material SUS304 / SUS316
Finish Polished / Satin / Matte Black / Gold
Gasket Type PVC / Black Rubber / Asbestos

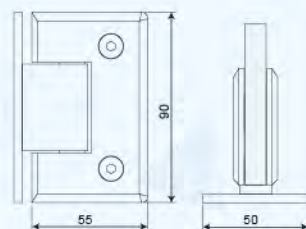

Art. No. SHT-C3-ST

Glass to Wall L Shape 90° Shower Hinge



Material SUS304 / SUS316
Finish Polished / Satin / Matte Black / Gold
Gasket Type PVC / Black Rubber / Asbestos

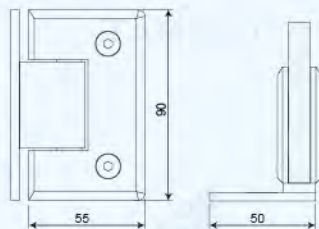

Art. No. SH135-C-ST

Glass to Glass 135° Shower Hinge



Material SUS304 / SUS316
Finish Polished / Satin / Matte Black / Gold
Gasket Type PVC / Black Rubber / Asbestos

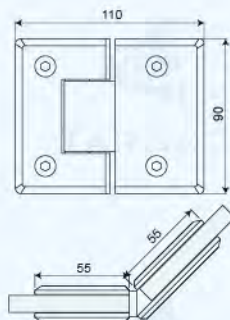

Stainless Steel Shower Hinge Standard Series



Art. No. SH180-C-ST

Glass to Glass 180° Shower Hinge



Material SUS304 / SUS316
Finish Polished / Satin / Matte Black / Gold
Gasket Type PVC / Black Rubber / Asbestos

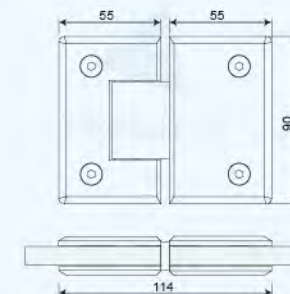

Art. No. SHL-C1-ST

Glass to Glass 90° Shower Hinge



Material SUS304 / SUS316
Finish Polished / Satin / Matte Black / Gold
Gasket Type PVC / Black Rubber / Asbestos

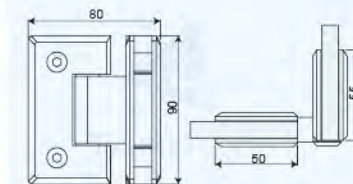

Fixed Bracket Standard Series



Art. No. GC00-A1-ST
Glass to Wall 90° Fixed Bracket



Material SUS304 / SUS316
Finish Polished / Satin / Matte Black / Gold
Gasket Type PVC / Black Rubber / Asbestos

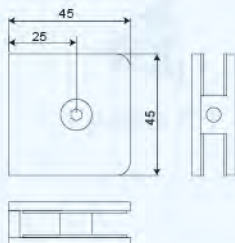

Art. No. GC00-A-ST
Glass to Wall 90° Fixed Bracket

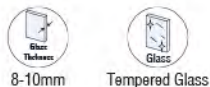

Material SUS304 / SUS316
Finish Polished / Satin / Matte Black / Gold
Gasket Type PVC / Black Rubber / Asbestos

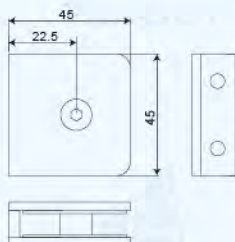

Art. No. GC90-A1-ST
Glass to Wall 90° Fixed Bracket



Material SUS304 / SUS316
Finish Polished / Satin / Matte Black / Gold
Gasket Type PVC / Black Rubber / Asbestos

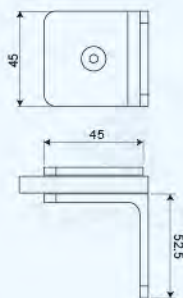

Art. No. GC90-A2-ST
Glass to Glass Double Sided 90° Fixed Bracket

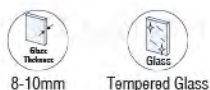

Material SUS304 / SUS316
Finish Polished / Satin / Matte Black / Gold
Gasket Type PVC / Black Rubber / Asbestos

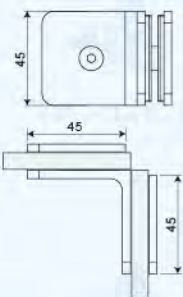

Fixed Bracket Standard Series



Art. No. GC135-A2-ST
Glass to Glass Double Sided 135° Fixed Bracket

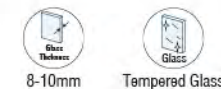

Material SUS304 / SUS316
Finish Polished / Satin / Matte Black / Gold
Gasket Type PVC / Black Rubber / Asbestos

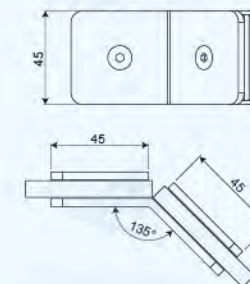

Art. No. GC180-A1-ST
Glass to Wall 180° Fixed Bracket

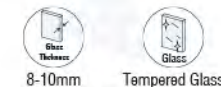

Material SUS304 / SUS316
Finish Polished / Satin / Matte Black / Gold
Gasket Type PVC / Black Rubber / Asbestos

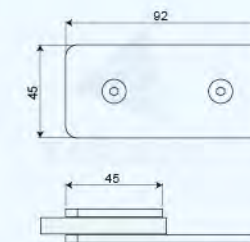

Art. No. GC180-A2-ST
Glass to Glass Double Sided 180° Fixed Bracket



Material SUS304 / SUS316
Finish Polished / Satin / Matte Black / Gold
Gasket Type PVC / Black Rubber / Asbestos

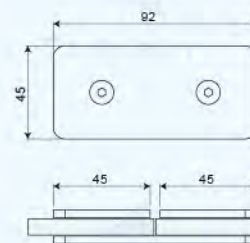

Fixed Bracket Standard Series



Art. No. GC00-B1-ST
Glass to Wall 90° Fixed Bracket



Material SUS304 / SUS316
Finish Polished / Satin / Matte Black / Gold
Gasket Type PVC / Black Rubber / Asbestos

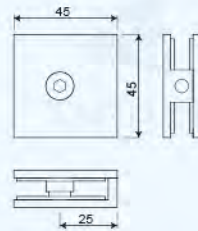

Art. No. GC00-B-ST
Glass to Wall 90° Fixed Bracket

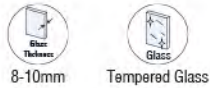

Material SUS304 / SUS316
Finish Polished / Satin / Matte Black / Gold
Gasket Type PVC / Black Rubber / Asbestos



Art. No. GC90-B1-ST
Glass to Wall 90° Fixed Bracket

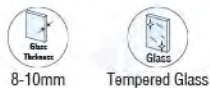

Material SUS304 / SUS316
Finish Polished / Satin / Matte Black / Gold
Gasket Type PVC / Black Rubber / Asbestos

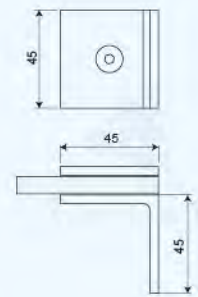

Art. No. GC90-B2-ST
Glass to Glass Double Sided 90° Fixed Bracket

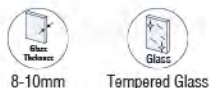

Material SUS304 / SUS316
Finish Polished / Satin / Matte Black / Gold
Gasket Type PVC / Black Rubber / Asbestos

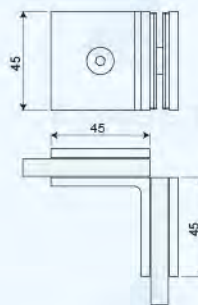

Fixed Bracket Standard Series



Art. No. GC135-B2-ST
Glass to Glass Double Sided 135° Fixed Bracket

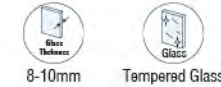

Material SUS304 / SUS316
Finish Polished / Satin / Matte Black / Gold
Gasket Type PVC / Black Rubber / Asbestos

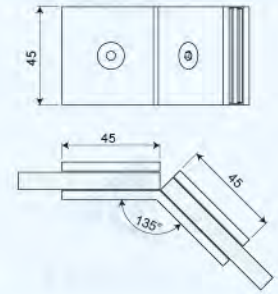

Art. No. GC180-B1-ST
Glass to Wall 180° Fixed Bracket

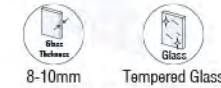

Material SUS304 / SUS316
Finish Polished / Satin / Matte Black / Gold
Gasket Type PVC / Black Rubber / Asbestos

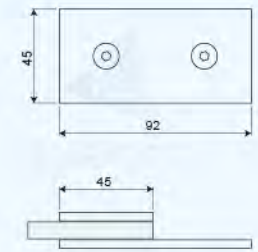

Art. No. GC180-B2-ST
Glass to Glass Double Sided 180° Fixed Bracket

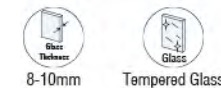

Material SUS304 / SUS316
Finish Polished / Satin / Matte Black / Gold
Gasket Type PVC / Black Rubber / Asbestos

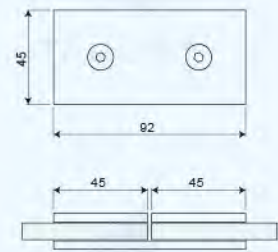

Art. No. GC90-B3-ST
Fixed Bracket

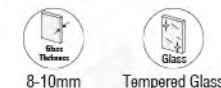

Material SUS304 / SUS316
Finish Polished / Satin / Matte Black / Gold
Gasket Type PVC / Black Rubber / Asbestos

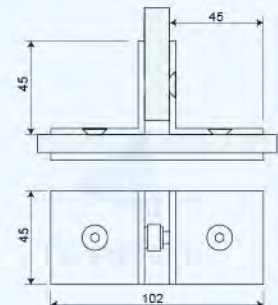

Fixed Bracket Standard Series



Art. No. GC00-C1-ST
Glass to Wall 90° Fixed Bracket



Material SUS304 / SUS316
Finish Polished / Satin / Matte Black / Gold
Gasket Type PVC / Black Rubber / Asbestos

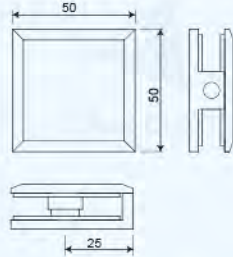

Art. No. GC00-C2-ST
Glass to Wall 90° Fixed Bracket

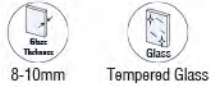

Material SUS304 / SUS316
Finish Polished / Satin / Matte Black / Gold
Gasket Type PVC / Black Rubber / Asbestos

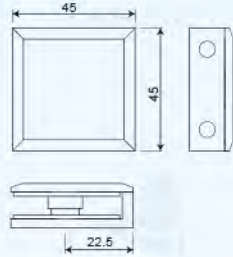

Art. No. GC90-C1-ST
Glass to Wall 90° Fixed Bracket

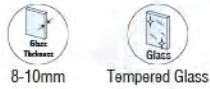

Material SUS304 / SUS316
Finish Polished / Satin / Matte Black / Gold
Gasket Type PVC / Black Rubber / Asbestos

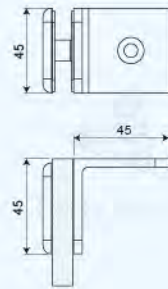

Art. No. GC90-C2-ST
Glass to Glass Double Sided 90° Fixed Bracket

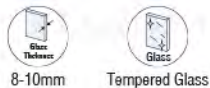

Material SUS304 / SUS316
Finish Polished / Satin / Matte Black / Gold
Gasket Type PVC / Black Rubber / Asbestos

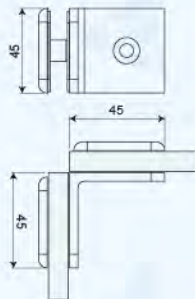

Fixed Bracket Standard Series



Art. No. GC135-C2-ST
Glass to Glass Double Sided 135° Fixed Bracket



Material SUS304 / SUS316
Finish Polished / Satin / Matte Black / Gold
Gasket Type PVC / Black Rubber / Asbestos

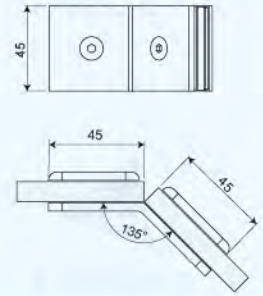

Art. No. GC180-C1-ST
Glass to Wall 180° Fixed Bracket



Material SUS304 / SUS316
Finish Polished / Satin / Matte Black / Gold
Gasket Type PVC / Black Rubber / Asbestos

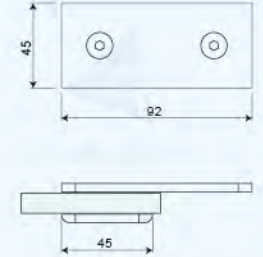

Art. No. GC180-C2-ST
Glass to Glass Double Sided 180° Fixed Bracket

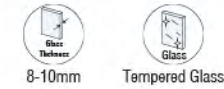

Material SUS304 / SUS316
Finish Polished / Satin / Matte Black / Gold
Gasket Type PVC / Black Rubber / Asbestos

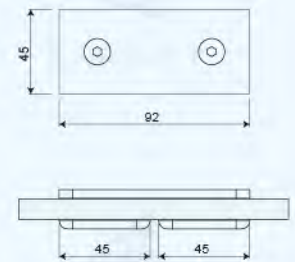

Glass Shelf Clamps

Typical 90° Application

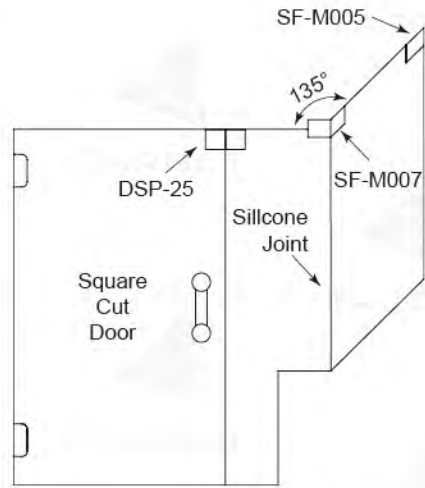

The SAC (Stabilizing Anchor Clamps) are used to help getting a very precise results in a very easy and convenient way when gluing two pieces of glass together by silicone. The clamps help to share the carrying of glass weight and performing as a stabilizing anchor that keeps the glass in position and allow the silicone to cure fully.

The clamps provide extra stability and rigidity for glass panels. There is no need for holes in the glass, simply tighten the grub screw and you are done.



Art. No. DSP-26

Door Stopper

Material
Brass
Finish
Chrome / Brushed Nickel / Matte Black

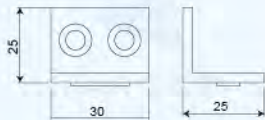

Art. No. DSP-25L



Art. No. DSP-25R

Door Stopper

Material
Brass
Finish
Chrome / Brushed Nickel / Matte Black

Glass Thickness
6-12mm Glass

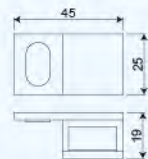

Art. No. DSP-27L



Art. No. DSP-27R

Door Stopper

Material
Brass
Finish
Chrome / Brushed Nickel / Matte Black

Glass Thickness
6-12mm Glass

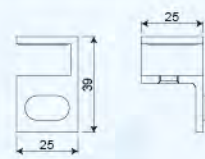

Glass Shelf Clamps



Art. No. SF-M003

Over Panel 90° Glass Clamp

Material
Brass
Finish
Chrome / Brushed Nickel / Matte Black

Glass Thickness
6-12mm Glass

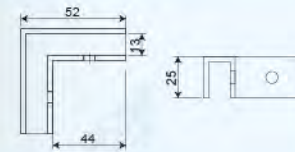

Art. No. SF-M004

180° Glass Clamp

Material
SUS304
Finish
Polished / Satin / Matte Black

Glass Thickness
6-12mm Glass

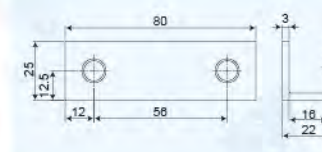

Art. No. SF-M007

135° Glass Clamp

Material
Brass
Finish
Chrome / Brushed Nickel / Matte Black

Glass Thickness
6-12mm Glass

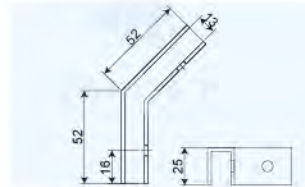

Art. No. SF-M009

Adjustable 90° to 180° Glass Clamp

Material
Brass
Finish
Chrome / Brushed Nickel / Matte Black

Glass Thickness
6-12mm Glass

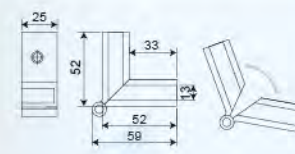

Art. No. SF-M005L

Left Wall Mount Glass Clamp

Material
Brass
Finish
Chrome / Brushed Nickel / Matte Black

Glass Thickness
6-12mm Glass

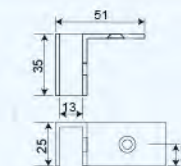

Art. No. SF-M005R

Right Wall Mount Glass Clamp

Material
Brass
Finish
Chrome / Brushed Nickel / Matte Black

Glass Thickness
6-12mm Glass

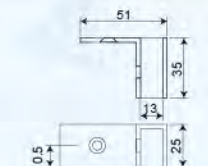

Shelf Bracket



Art. No. GC-H

Shelf Bracket

Material

Brass

Finish

Chrome / Brushed Nickel / Matte Black

Glass Thickness

6-12mm Glass

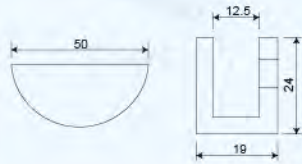

Art. No. GC-S

Shelf Bracket

Material

Brass

Finish

Chrome / Brushed Nickel / Matte Black

Glass Thickness

6-12mm Glass

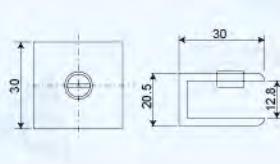

Art. No. GC-S-ST

Shelf Bracket

Material

SUS304

Finish

Polished / Satin / Matte Black

Glass Thickness

6-12mm Glass

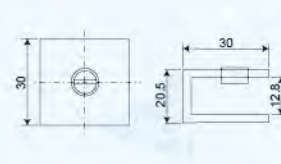

Art. No. GC-L1

Shelf Bracket

Material

Brass

Finish

Chrome / Brushed Nickel / Matte Black

Glass Thickness

6-10mm Glass



Art. No. GC-L

Shelf Bracket

Material

Brass

Finish

Chrome / Brushed Nickel / Matte Black

Glass Thickness

6-10mm Glass

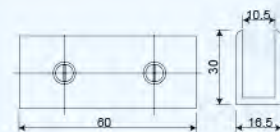

Art. No. GC-Q

Wall-mounted Shelf Bracket

Material

Brass

Finish

Chrome / Brushed Nickel / Matte Black

Glass Thickness

6-10mm Glass



Shelf Bracket



Art. No. GC00-Q

Glass-mounted Shelf Bracket

Material

Brass

Finish

Chrome / Brushed Nickel / Matte Black

Glass Thickness

6-10mm Glass

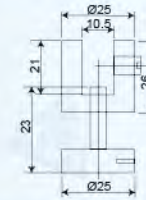

Art. No. GC180-Q

Back to Back Shelf Bracket

Material

Brass

Finish

Chrome / Brushed Nickel / Matte Black

Glass Thickness

6-10mm Glass

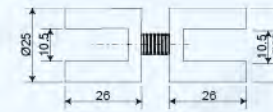

Art. No. GC-M003

Shelf Bracket

Material

Brass

Finish

Chrome / Brushed Nickel / Matte Black

Glass Thickness

8-10mm Glass

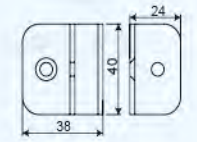

Art. No. GC-M003B

Shelf Bracket
GC-M003B-A L40xW24xH38mm
GC-M003B-B L50xW24xH43mm

Material

Brass

Finish

Chrome / Brushed Nickel / Matte Black

Glass Thickness

6-12mm Glass

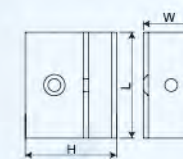

Art. No. GC-F1

Shelf Bracket
GC-F1-A L76xW30xH67mm
GC-F1-B L56xW28xH55mm

Material

Zinc Alloy

Finish

Chrome / Brushed Nickel / Matte Black

Glass Thickness

6-12mm Glass

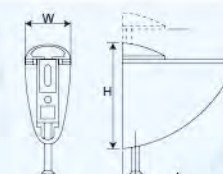

Art. No. GC-F2

Shelf Bracket
GC-F2-A L40xW21xH1 26xH2 16mm
GC-F2-B L50xW40xH1 34xH2 16mm

Material

Zinc Alloy

Finish

Chrome / Brushed Nickel / Matte Black

Glass Thickness

6-12mm Glass

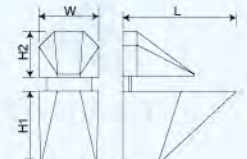

Shower Connector & Rods



Round Stabilizer Bar Series

For Ø19 / Ø25 Tube

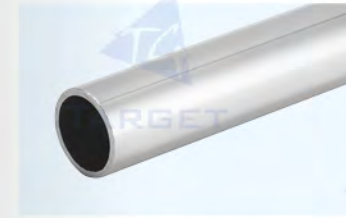

Art. No. TB-19A
Round Tube

Material
SUS304 / SUS316

Finish
Polished / Satin / Matte Black

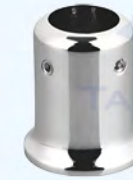

Art. No. SC-1A
Wall Mounting Connector

Material
Brass

Finish
Chrome / Brushed Nickel / Matte Black



Art. No. SC-2A
Tee connector

Material
Brass

Finish
Chrome / Brushed Nickel / Matte Black



Art. No. SC-2B
Tee connector

Material
Brass

Finish
Chrome / Brushed Nickel / Matte Black



Art. No. SC-2C
End Connector

Material
Brass

Finish
Chrome / Brushed Nickel / Matte Black



Art. No. SC-3
135° Corner Connector

Material
SUS304 / SUS316

Finish
Polished / Satin / Matte Black



Art. No. SC-3A
Adjustable Connector

Material
Brass

Finish
Chrome / Brushed Nickel / Matte Black



Art. No. SC-4
90° Corner Connector

Material
SUS304 / SUS316

Finish
Polished / Satin / Matte Black



Art. No. SC-5
Tee Coupler

Material
SUS304 / SUS316

Finish
Polished / Satin / Matte Black

Round Stabilizer Bar Series

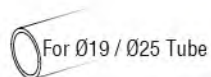

Art. No. SC-8
45° Wall Mounting Bracket

Material
Brass

Finish
Chrome / Brushed Nickel / Matte Black



Art. No. SC-33
Tee Connector

Material
Brass

Finish
Chrome / Brushed Nickel / Matte Black



Art. No. SC-9
End Connector

Material
Brass

Finish
Chrome / Brushed Nickel / Matte Black



Art. No. SC-10
Wall Mounting Bracket

Material
Brass

Finish
Chrome / Brushed Nickel / Matte Black



Art. No. SC-11
End Connector

Material
Brass

Finish
Chrome / Brushed Nickel / Matte Black



Art. No. SC-40
End Connector

Material
Brass

Finish
Chrome / Brushed Nickel / Matte Black



Art. No. SC-1
Wall Mounting Connector

Material
Brass

Finish
Chrome / Brushed Nickel / Matte Black



Art. No. SC-15
End Connector

Material
Brass

Finish
Chrome / Brushed Nickel / Matte Black



Art. No. SC-2
Tee Coupler

Material
Brass

Finish
Chrome / Brushed Nickel / Matte Black

Square Stabilizer Bar Series

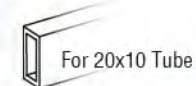

Art. No. TQ-20-10
Rectangular Tube

Material
SUS304 / SUS316

Finish
Polished / Satin / Matte Black



Art. No. SC-46
Wall Mounting Connector

Material
SUS304 / SUS316

Finish
Polished / Satin / Matte Black



Art. No. SC-47
Connector

Material
SUS304 / SUS316

Finish
Polished / Satin / Matte Black



Art. No. SC-48
End Connector

Material
SUS304 / SUS316

Finish
Polished / Satin / Matte Black



Art. No. SC-49
Connector

Material
SUS304 / SUS316

Finish
Polished / Satin / Matte Black



Art. No. SC-52
Adjustable Connector

Material
SUS304 / SUS316

Finish
Polished / Satin / Matte Black



Art. No. SC-51
End Connector

Material
SUS304 / SUS316

Finish
Polished / Satin / Matte Black



Art. No. SC-44
Adjustable Wall Mounting Connector

Material
SUS304 / SUS316

Finish
Polished / Satin / Matte Black



Art. No. SC-45
Tee Connector

Material
SUS304 / SUS316

Finish
Polished / Satin / Matte Black

Square Stabilizer Bar Series

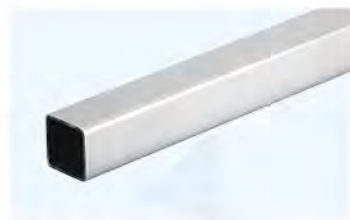
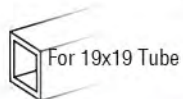

Art. No. TB-19SQ

Square Tube

Material
SUS304 / SUS316

Finish
Polished / Satin / Matte Black



Art. No. SQ-1A

Wall Mounting Connector

Material
Brass

Finish
Chrome / Brushed Nickel / Matte Black



Art. No. SQ-2B

Tee Coupler

Material
Brass

Finish
Chrome / Brushed Nickel / Matte Black



Art. No. SQ-2C

End Connector

Material
Brass

Finish
Chrome / Brushed Nickel / Matte Black



Art. No. SQ-8

45° Wall Mounting Connector

Material
Brass

Finish
Chrome / Brushed Nickel / Matte Black

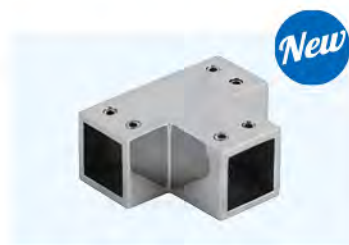

Art. No. SQ-5

Tee Coupler

Material
Brass

Finish
Chrome / Brushed Nickel / Matte Black

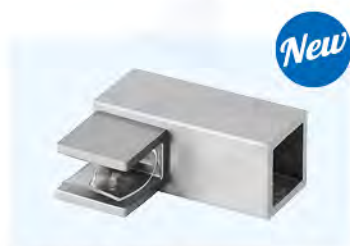

Art. No. SQ-2D

End Connector

Material
Brass

Finish
Chrome / Brushed Nickel / Matte Black

Rectangular Stabilizer Bar Series

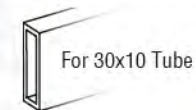

Art. No. OF-WS-8

Rectangular Tube

Material
SUS304 / SUS316

Finish
Polished / Satin / Matte Black



Art. No. OF-WS-4

Wall Mounting Connector

Material
SUS304 / SUS316

Finish
Polished / Satin / Matte Black



Art. No. OF-WS-18

End Connector

Material
SUS304 / SUS316

Finish
Polished / Satin / Matte Black



Art. No. OF-WS-15

Tee Coupler

Material
SUS304 / SUS316

Finish
Polished / Satin / Matte Black



Art. No. OF-WS-16

Tee Coupler

Material
SUS304 / SUS316

Finish
Polished / Satin / Matte Black



Art. No. OF-WS-20

End Connector

Material
SUS304 / SUS316

Finish
Polished / Satin / Matte Black

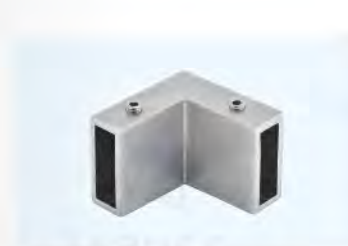

Art. No. OF-WS-6

90° Corner Bracket

Material
SUS304 / SUS316

Finish
Polished / Satin / Matte Black



Art. No. OF-WS-19

End Connector

Material
SUS304 / SUS316

Finish
Polished / Satin / Matte Black



Art. No. OF-WS-22

135° Corner Connector

Material
SUS304 / SUS316

Finish
Polished / Satin / Matte Black



Stabilizer Bar Series

Stabilizer bar

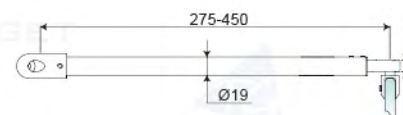

Art. No. SR-95
Stabilizer bar Glass to Wall

Material
 Brass & SUS304
Finish
 Chrome / Brushed Nickel / Matte Black

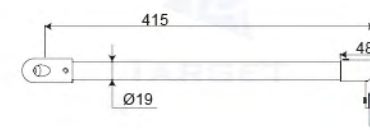

Art. No. SR-96B
Stabilizer bar Glass to Wall

Material
 Brass & SUS304
Finish
 Chrome / Brushed Nickel / Matte Black

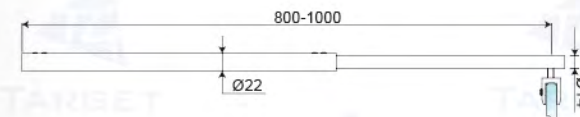

Art. No. SR-91
Stabilizer bar Glass to Wall

Material
 Brass & SUS304
Finish
 Chrome / Brushed Nickel / Matte Black

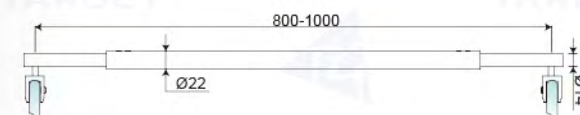

Art. No. SR-90
Stabilizer bar Glass to Glass

Material
 Brass & SUS304
Finish
 Chrome / Brushed Nickel / Matte Black

Stabilizer bar

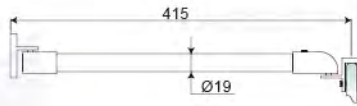

Art. No. SR-100
Stabilizer bar Glass to Wall

Material
Brass & SUS304
Finish
Chrome / Brushed Nickel / Matte Black

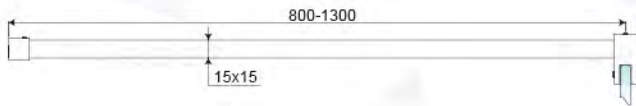

Art. No. SR-107
Stabilizer bar Glass to Wall

Material
Brass & SUS304
Finish
Chrome / Brushed Nickel / Matte Black

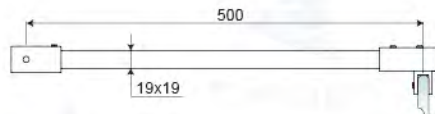

Art. No. SR-134
Stabilizer bar Glass to Wall

Material
Brass & SUS304
Finish
Chrome / Brushed Nickel / Matte Black

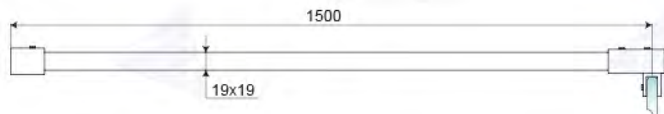

Art. No. SR-135
Stabilizer bar Glass to Wall

Material
Brass & SUS304
Finish
Chrome / Brushed Nickel / Matte Black

Stabilizer bar

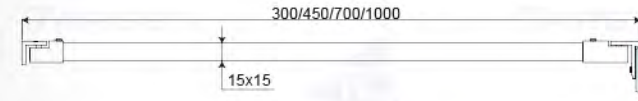

Art. No. SR-001S
Stabilizer bar Glass to Wall

Material
Zinc Alloy & SUS304
Finish
Chrome / Brushed Nickel / Matte Black

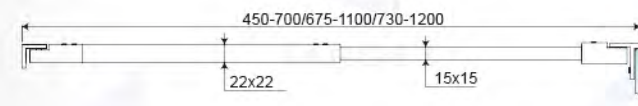

Art. No. SR-108
Stabilizer bar Glass to Wall

Material
Zinc Alloy & SUS304
Finish
Chrome / Brushed Nickel / Matte Black

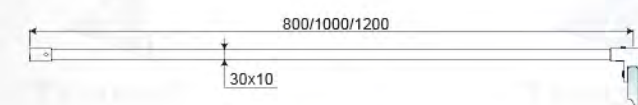

Art. No. SR-111
Stabilizer bar Glass to Wall

Material
Brass & SUS304
Finish
Chrome / Brushed Nickel / Matte Black

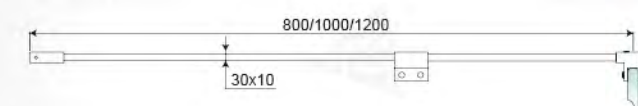

Art. No. SR-112
Stabilizer bar Glass to Wall

Material
Brass & SUS304
Finish
Chrome / Brushed Nickel / Matte Black



Shower Kits SF-Q Series

- SF-Q shower door is a wonderful design for compact area, which has no wall profile design, combining the beauty of frameless glass with the convenience of sliding door.
- Using a unique header and roller design, this enclosure brings a sleek and clean look to your bathroom.
- This sliding door system comes with one fixed panel and one sliding door. With SF-05Q, it can easily connect side panel to transform into 90 degree glass-to-glass application.



Art. No. SF-20Q
Roller



Art. No. SF-03Q
Fixed Clamp (track to glass)



Art. No. SF-04Q
Door Stopper

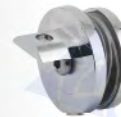

Art. No. SF-05Q
90° Corner Clamp



Art. No. SF-07Q
Side Mount



Art. No. SK-09
Glass Door Handle



Art. No. SF-06Q
Glass clamp



Art. No. SF-09Q
Floor Guide



Art. No. SF-01Q
Header Support Bar
Standard Length: 2000mm



8-10mm



40kg



1000mm



Tempered Glass

Material

Brass Fittings, Anodized Aluminum Sliding Door Track

Finish

Chrome / Satin Nickel

Glass Thickness

8-10mm

Glass Fabrication Required

Holes required in fixed panel and door

Standard 180 degree Kits Include

- | | |
|------------|-------------------------------|
| 2 x SF-20Q | Roller |
| 2 x SF-03Q | Fixed Clamp (track to glass) |
| 2 x SF-04Q | Door stopper |
| 2 x SF-07Q | Side Mount |
| 1 x SF-09Q | Floor Guide |
| 1 x SK-09 | Glass Door Handle |
| 1 x SF-01Q | L=2000mm (Header support bar) |



Shower Kits OF-W Series

Shower Kits OF-W Series

- OF-W sliding system works with round tube of Dia 25mm and 8-10mm toughened safety glass.
- This sliding door system comes with one fixed panel and one sliding door.
- Rolling-In-Glass system is a stunning sliding system that utilizes minimum hardware, offering a completely frameless appearance.

 Art. No. OF-W <i>Roller</i>	 Art. No. OF-YA <i>Fixed Clamp(track to glass)</i>	 Art. No. OF-A-7 <i>Door Stopper</i>	 Art. No. SC-1A <i>Tube Support</i>
 Art. No. OF-P <i>Safe Pin</i>	 Art. No. SKR-02 <i>Glass Door Handle</i>	 Art. No. OF-A-9 <i>Floor Guide</i>	 Art. No. TB-25A <i>Header support bar</i> <i>Standard Length: 2000mm</i>

-  8-10mm
-  40kg
-  1000mm
-  Tempered Glass

- Standard 180 degree Kits Include**
- 2 x OF-W Roller
 - 2 x SC-1A Tube Connector
 - 1 x OF-P Safe Pin
 - 2 x OF-YA Fixed Clamp(track to glass)
 - 2 x OF-A-7 Door stopper
 - 1 x SKR-02 Glass door handle
 - 1 x OF-A-9 Floor guide
 - 1 x TB-25A L=2000mm (Header support bar)

Material	SUS304 / SUS316
Finish	Polished / Satin
Glass Thickness	8-10mm
Glass Fabrication Required	Holes required in fixed panel and door

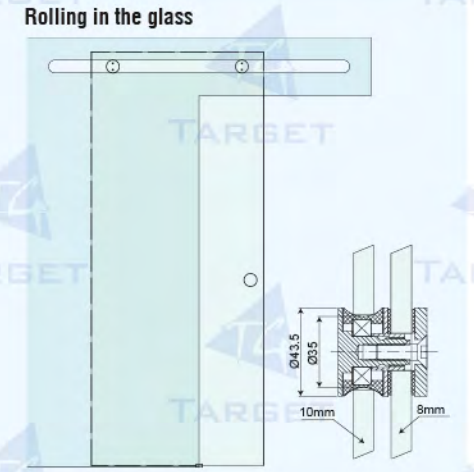



Shower Kits OF-WS Series

- The OF-WS Sliding System has an entirely different look from traditional sliding shower systems.
- The use of minimal hardware provides a frameless look that gives the enclosure an almost floating appearance.
- This sliding door system comes with one fixed panel and one sliding door.
- Smooth and quiet operation is guaranteed by excellent shower door engineering and simple design.
- This sliding kit will absolutely make your bathroom more modern and bright as well.



Art. No. OF-WS
Roller



Art. No. OF-WS-2
Fixed Clamp(track to glass)



Art. No. OF-WS-5
Door Stopper



Art. No. OF-WS-4
Tube Support



Art. No. OF-WS-3Q
Safe Pin



Art. No. SF-04S
Glass Door Handle

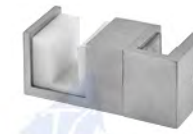

Art. No. OF-WS-9
Floor Guide



Art. No. OF-WS-8
Header Support Bar
Standard Length: 2000mm



Art. No. OF-WS-6
90° Connector



Art. No. OF-WS-4Q
Tube to Glass connector



8-10mm



40kg



1000mm



Tempered Glass

Material

SUS304 / SUS316

Finish

Polished / Satin

Glass Thickness

8-10mm

Glass Fabrication Required

Holes required in fixed panel and door

Standard 180 degree Kits Include

- | | |
|--------------|-------------------------------|
| 2 x OF-WS | Roller |
| 2 x OF-WS-2 | Fixed Clamp(track to glass) |
| 2 x OF-WS-3Q | Safe pin |
| 2 x OF-WS-5 | Door Stoppers |
| 2 x OF-WS-4 | Tube Support |
| 1 x OF-WS-9 | Floor Guide |
| 1 x SF-04S | Glass door handle |
| 1 x OF-WS-8 | L=2000mm (Header support bar) |

OF-W-55 Series Sliding Shower Doors

Sliding Shower Doors

- Sleek, unobstructed lines with hints of luxury create a timeless shower door.
- Designed for use with 8 or 10mm Tempered Glass.
- Maximum Weight for Sliding Door is 45kg.
- 2000mm Maximum Opening Width, Field Cut to Size.
- Circular Shaped Headers and Rollers.
- Two Sliding Roller ensure Door Slides Open and Closed Smoothly and Quietly.



Art. No. OF-W-55
Track Roller



Art. No. SF-2H
Track connector for fixed panel



Art. No. SF-4H
Stopper



Art. No. SC-1
Track holder for wall



Art. No. OF-P-25
Safe Pin



Art. No. SF-04S
Glass Door Handle



Art. No. OF-A-9
Floor Guide



Art. No. TB-25A
Header support bar

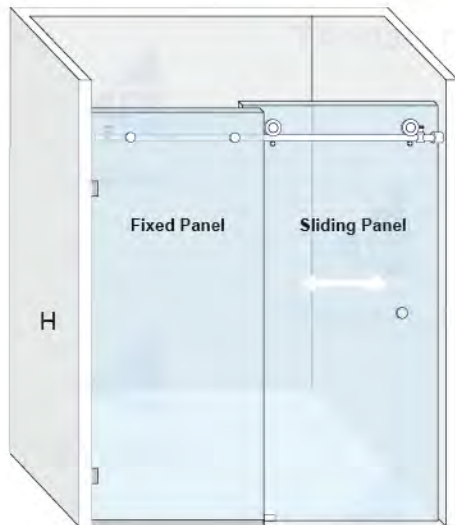

Material	SUS304 / SUS316
Finish	Polished / Satin / Matte Black / Gold
Application	One Sliding Panel and one fixed panel Optional 90 degree return.
Max Door Weight	45kg
Max Door Width	915mm
Glass Thickness	8-10mm Tempered Glass

Standard 180 degree Kits Include

2 x OF-W-55	Track Roller
2 x SF-4H	Stopper
1 x TB-25A	Header support bar
2 x OF-P-25	Safe Pin
2 x SF-2H	Track connector for fixed panel
2 x SC-1	Track holder for wall
1 x OF-A-9	Floor Guide
1 x SF-04S	Glass Door Handle

OF-W-70 Series Sliding Shower Doors

Sliding Shower Doors

- The circular shaped header and the round rollers are the perfect complement to each other.
- Designed for use with 8 or 10mm Tempered Glass.
- Maximum Weight for Sliding Door is 45kg.
- 2000mm Maximum Opening Width, Field Cut to Size.
- Circular Shaped Headers and Rollers.
- Four Sliding Roller ensure Door Slides Open and Closed Smoothly and Quietly.



Art. No. OF-W-70
Track Roller



Art. No. SF-2H
Track connector for fixed panel



Art. No. SF-5H
Stopper



Art. No. SC-1
Track holder for wall



Art. No. SF-04S
Glass Door Handle



Art. No. OF-A-9
Floor Guide



Art. No. TB-25A
Header support bar

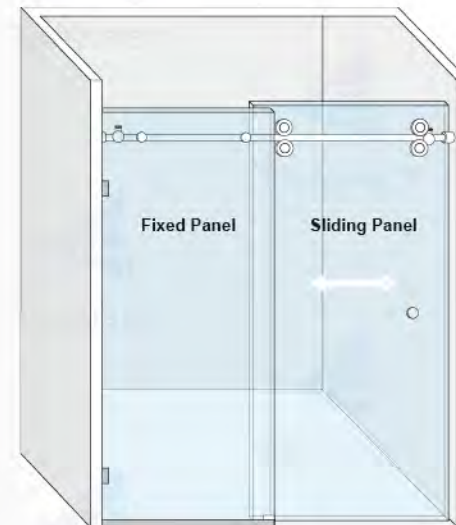

Material	SUS304 / SUS316
Finish	Polished / Satin / Matte Black / Gold
Application	One Sliding Panel and one fixed panel Optional 90 degree return.
Max Door Weight	45kg
Max Door Width	915mm
Glass Thickness	8-10mm Tempered Glass

Standard 180 degree Kits Include

4 x OF-W-70	Track Roller
2 x SF-5H	Stopper
1 x TB-25A	Header support bar
1 x OF-A-9	Floor Guide
2 x SF-2H	Track connector for fixed panel
2 x SC-1	Track holder for wall
1 x SF-04S	Glass Door Handle



Shower Kits SF180-P1 Series

- Framed shower cabinet, apply high quality aluminum profile and glass.
- SF180-P1 Series is 8mm glass sliding door system



Art. No. SF-00P
Roller



Art. No. SF-01P
Header Support Bar
Standard Length: 2000mm



Art. No. SF-04P
Glass Door Handle



Art. No. SF-14P
Floor Guide

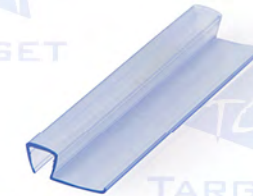

Art. No. PS-27
Bottom Seal



Art. No. PS-11
Sliding Seal



8mm



40kg



1000mm



Tempered Glass

Material	Brass Fittings, Aluminum Track
Finish	Chrome / Satin Nickel / Black
Glass Thickness	8mm
Glass Fabrication Required	Holes required in sliding door

Standard 180 degree Kits Include

- 2 x SF-00P Roller
- 1 x SF-01P L=2000mm (Header support bar)
- 1 x SF-04P Glass Door Handle
- 2 x SF-14P Floor Guide
- 1 x PS-27 Bottom Seal
- 1 x PS-11 Sliding Seal



Shower Door Header Kits



- The 360° pivot hinges are used at the top and bottom of the door. They can be mounted to top header for units that do not extend to ceilings.
- You can also use these hinges without the header if the glass is going all the way to the ceiling.
- Besides SL-100, we can offer header SFL-113 of different style for you.
- Accessories include a snap-in filler insert, adapter block, wall mount brackets and PVC Seal.

- Available Finished:
- Chrome / Brushed Nickel / Matte Black / Satin Brass
- Fixed Panel Thickness: 10mm
- Suggested Length: 3658mm / 2489mm / 1676mm

Optional Accessories



Art. No. SF-C135
135° Connector



Art. No. SF-C04
Adapter Block



Art. No. SF-C360
Adjustable Connector



Art. No. SF-C06
Wall Connector



Art. No. SF-C11
Wall Connector

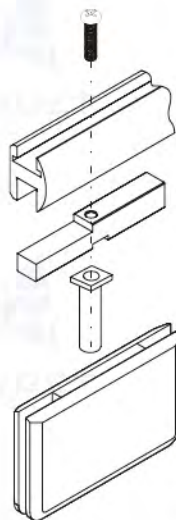

Shower Door Header Kits

Art. No. SH360-B-C For 10mm Glass

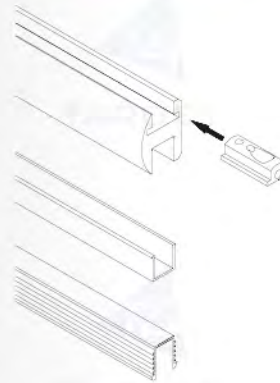

Art. No. SL-100
Round Header Support Bar

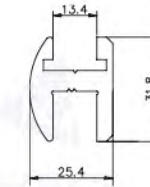

Art. No. SL-101
U channel

Art. No. SFL-113
Flat Header Support Bar

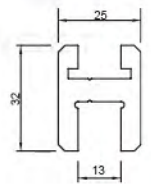

Art. No. PS-15B
U channel



Art. No. SF-C06
Wall Connector

Art. No. SH360-SS For 6mm Glass

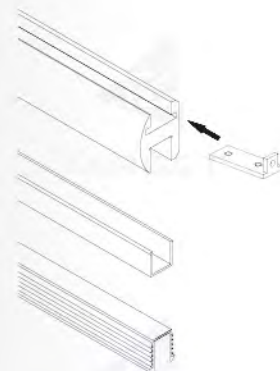

Art. No. SL-100-S

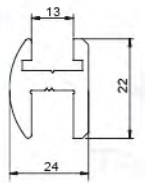
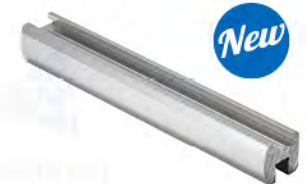

Art. No. SL-101-S
U channel

Art. No. PS-15B-6
U channel

Art. No. SF-C11
Wall Connector

Art. No. SF-C360-S
Adjustable Connector

- Available Finished: Chrome / Brushed Nickel / Matte Black / Satin Brass
- Fixed Panel Thickness: 6mm
- Suggested Length: 1676mm / 2489mm

Shower Kits SL-020E Series



- SL-020E utilizes aluminium header for a traditional frameless sliding shower door appearance.
- Top concealed hangers allow quick and easy installation.
- This kit comes in Bright Anodized, Brushed Anodized, Silver Anodized and Matte Black finishes.
- Custom finish is available on special order.
- This sliding door system comes with one fixed panel and one sliding door.



Art. No. SL-020E-A
Track Roller



Art. No. SL-020E-B
Track Holder For Wall



Art. No. SL-020E-C
Door Stopper



Art. No. SF-04S
Sliding Handle



Art. No. OF-A-9E
Floor Guide



Art. No. SL-020E
Track

Optional Accessories for 90° Shower Door



Art. No. SL-020E-D
90° Corner Joint

Maximum Door Weight	50kg
Maximum Door Width	750mm
Maximum Door Height	2000mm
Maximum Glass Thickness	8-10mm

Standard 180 degree Kis Include

- 2 x SL-020E-A Track Roller
- 2 x SL-020E-C Door Stopper
- 1 x SL-020E Track
- 2 x SL-020E-B Track holder for wall
- 1 x OF-A-9E Floor Guide
- 1 x SF-04S Sliding handle

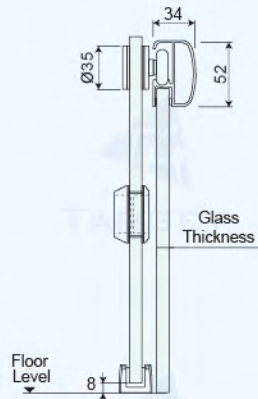

Pull Knobs

Pull Knobs



Art. No. SK-01

Double Pull Knob

Material

Brass

Finish

Chrome / Brushed Nickel / Matte Black



Art. No. SK-02

Double Pull Knob

Material

Brass

Finish

Chrome / Brushed Nickel / Matte Black



Art. No. SK-03

Double Pull Knob

Material

Brass

Finish

Chrome / Brushed Nickel / Matte Black

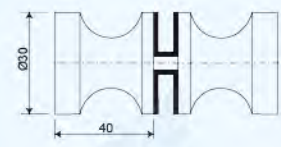
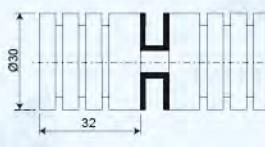
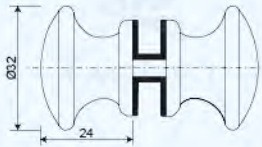

Art. No. SK-04

Double Pull Knob

Material

Brass

Finish

Chrome / Brushed Nickel / Matte Black



Art. No. SK-05

Double Pull Knob

Material

Brass

Finish

Chrome / Brushed Nickel / Matte Black



Art. No. SK-66

Double Pull Knob

Material

Brass

Finish

Chrome / Brushed Nickel / Matte Black

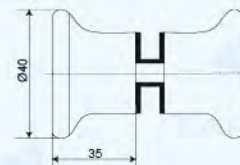

Pull Knobs



Art. No. SK-08

Double Pull Knob

Material

Brass

Finish

Chrome / Brushed Nickel / Matte Black



Art. No. SK-09

Double Pull Knob

Material

Brass

Finish

Chrome / Brushed Nickel / Matte Black



Art. No. SK-33

Double Pull Knob

Material

Brass

Finish

Chrome / Brushed Nickel / Matte Black

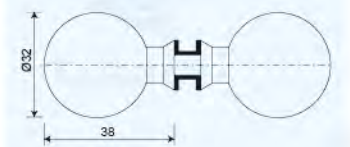
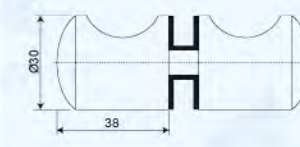
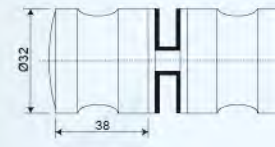

Art. No. SK-09S

Single Pull Knob

Material

Brass

Finish

Chrome / Brushed Nickel / Matte Black



Art. No. SK-37

Double Pull Knob

Material

Brass

Finish

Chrome / Brushed Nickel / Matte Black



Art. No. SK-39

Double Pull Knob

Material

Brass

Finish

Chrome / Brushed Nickel / Matte Black

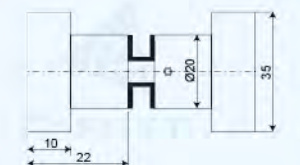
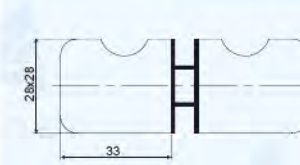
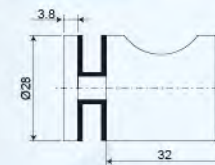

Pull Knobs



Art. No. SK-110

Double Pull Knob

Material

Brass

Finish

Chrome / Brushed Nickel / Matte Black

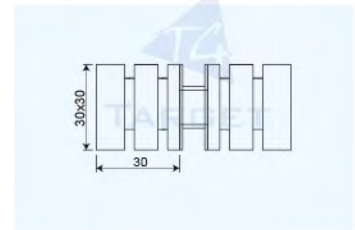

Art. No. SK-53S

Double Pull Knob

Material

Brass

Finish

Chrome / Brushed Nickel / Matte Black

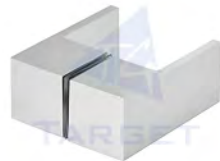
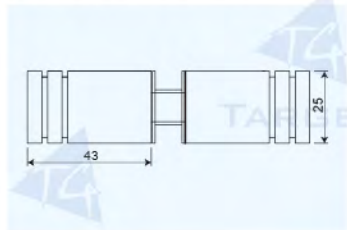

Art. No. SK-56

Double Pull Knob

Material

Brass

Finish

Chrome / Brushed Nickel / Matte Black

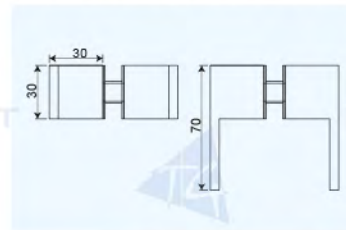

Art. No. SGK-01

Double Pull Knob

Material

SUS304 + Glass

Finish

Polished / Satin / Matte Black

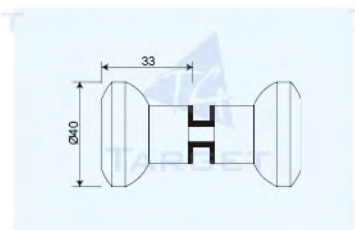

Art. No. SGK-02

Double Pull Knob

Material

SUS304 + Glass

Finish

Polished / Satin / Matte Black

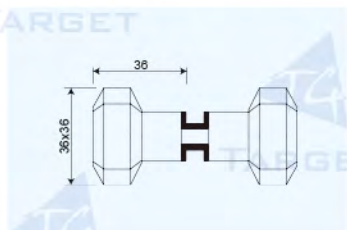

Art. No. SGK-03

Double Pull Knob

Material

SUS304 + Glass

Finish

Polished / Satin / Matte Black

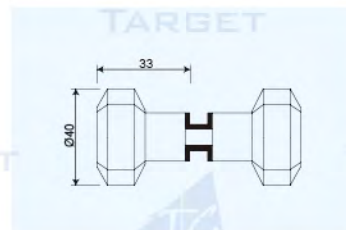

PVC Seals Profile



Magnetic PVC Seal

Glass Thickness
6-12mm Toughened Safety Glass

Material
PVC

Finish
Clear / Matte Black

Standard Length
2200 / 2500mm



Art. No. PS-8M

GLASS THICKNESS	DISTANCE (D)
6mm	23mm
8mm	24mm
10mm	20mm
12mm	24mm

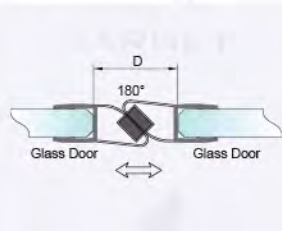

Art. No. PS-9M

GLASS THICKNESS	DISTANCE (D)
6mm	12mm
8mm	11mm
10mm	11mm
12mm	11mm

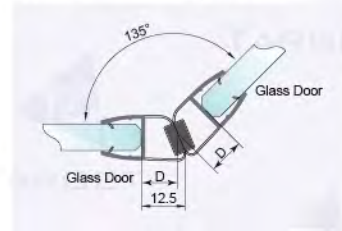

Art. No. PS-10M

GLASS THICKNESS	DISTANCE (D)
6mm	12mm
8mm	12mm
10mm	12mm
12mm	12mm

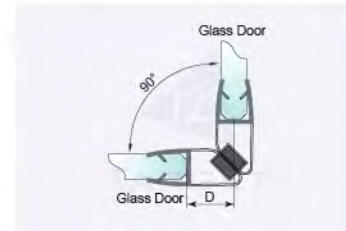

Art. No. PS-30M

GLASS THICKNESS	DISTANCE (D)
8mm	24mm
10mm	20mm

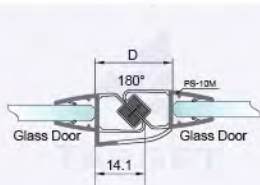

Art. No. PS-40M

GLASS THICKNESS	DISTANCE (D)
6mm	20mm
8mm	21mm
10mm	22mm
12mm	22mm

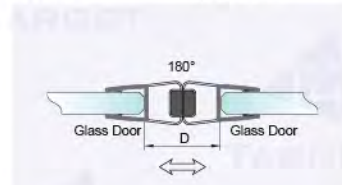

Art. No. PS-42M

GLASS THICKNESS	DISTANCE (D)
6mm	25mm
8mm	25mm
10mm	24mm
12mm	24mm

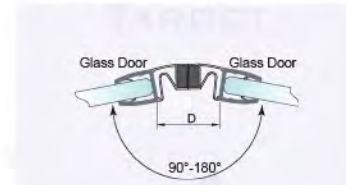

Magnetic PVC Seal

Glass Thickness
6-12mm Toughened Safety Glass

Material
PVC

Finish
Clear / Matte Black

Standard Length
2200 / 2500mm

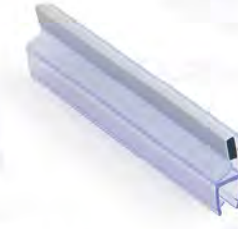

Art. No. PS-50M

GLASS THICKNESS	DISTANCE (D)
6mm	14.4mm
8mm	14.4mm

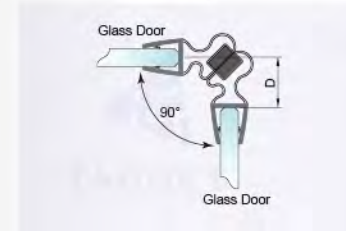

Art. No. PS-53M

GLASS THICKNESS	DISTANCE (D)
8mm	23mm
10mm	25mm

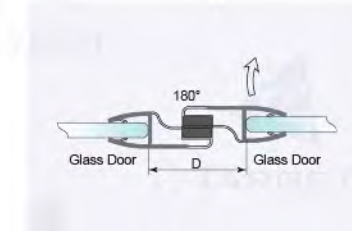

Art. No. PS-56M

GLASS THICKNESS	DISTANCE (D)
8mm	21mm
10mm	22mm

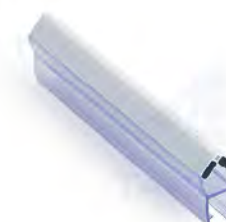
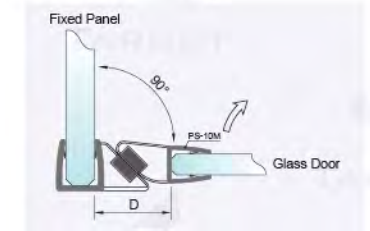

Art. No. PS-57M

GLASS THICKNESS	DISTANCE (D)
8mm	20mm
10mm	22mm

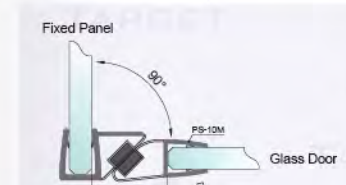

Art. No. PS-58M

GLASS THICKNESS	DISTANCE (D)
8mm	32mm
10mm	32mm

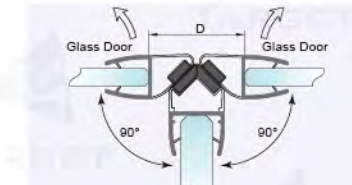

Art. No. PS-59M

GLASS THICKNESS	DISTANCE (D)
8mm	4mm
10mm	4mm

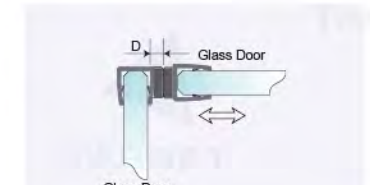

Magnetic PVC Seal

Glass Thickness
6-12mm Toughened Safety Glass

Material
PVC

Finish
Clear / Matte Black

Standard Length
2200 / 2500mm

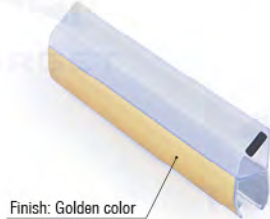

Art. No. PS-8M-S

GLASS THICKNESS	DISTANCE (D)
6mm	22mm
8mm	24mm
10mm	20mm
12mm	25mm

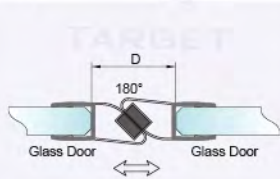

Art. No. PS-9M-G

GLASS THICKNESS	DISTANCE (D)
6mm	12mm
8mm	11mm
10mm	11mm
12mm	11mm

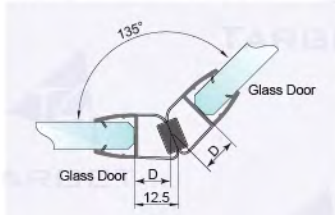

Art. No. PS-10M-G

GLASS THICKNESS	DISTANCE (D)
6mm	12mm
8mm	12mm
10mm	12mm
12mm	12mm

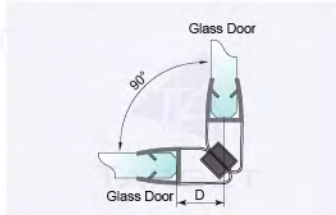

PVC Seal

Glass Thickness
6-12mm Toughened Safety Glass

Material
PVC

Finish
Clear / Matte Black

Standard Length
2200 / 2500mm

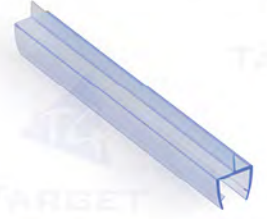
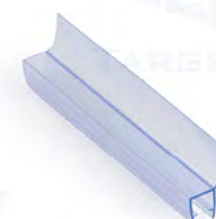
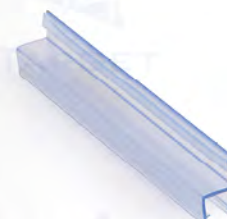

Art. No. PS-1

GLASS THICKNESS	LENGTH (L)
6mm	9.5mm
8mm	9.5mm
10mm	10mm
12mm	10mm

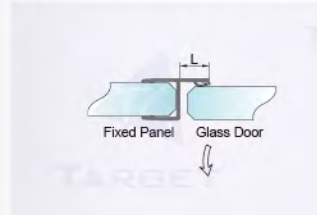

Art. No. PS-2

GLASS THICKNESS	LENGTH (L)
6mm	15mm
8mm	15mm
10mm	15mm
12mm	15mm

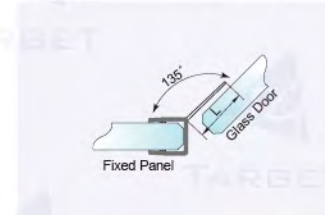

Art. No. PS-3

GLASS THICKNESS	HIGH (H)
6mm	5.5mm
8mm	5.5mm
10mm	5.5mm
12mm	5.5mm

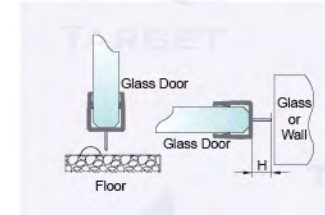

Art. No. PS-3H

GLASS THICKNESS	HIGH (H)
6mm	4mm
8mm	4mm
10mm	4mm
12mm	4mm

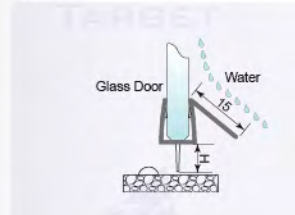

Art. No. PS-4

GLASS THICKNESS	HIGH (H)
6mm	7mm
8mm	7mm
10mm	7mm
12mm	7mm

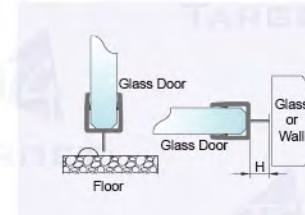

Art. No. PS-5

GLASS THICKNESS	LENGTH (L)
6mm	6.5mm
8mm	6.5mm
10mm	8mm
12mm	6.5mm

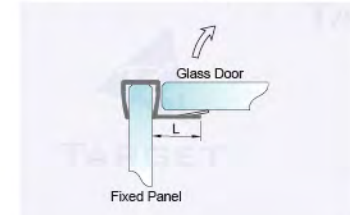

PVC Seal

Glass Thickness
6-12mm Toughened Safety Glass

Material
PVC

Finish
Clear / Matte Black

Standard Length
2200 / 2500mm



Art. No. PS-6

GLASS THICKNESS	LENGTH (L)
6mm	8mm
8mm	8mm
10mm	8mm
12mm	8mm

Art. No. PS-6H

GLASS THICKNESS	LENGTH (L)
8mm	10mm
10mm	10mm
12mm	12mm

Art. No. PS-6HS

GLASS THICKNESS	LENGTH (L)
6mm	20mm
8mm	20mm
10mm	20mm

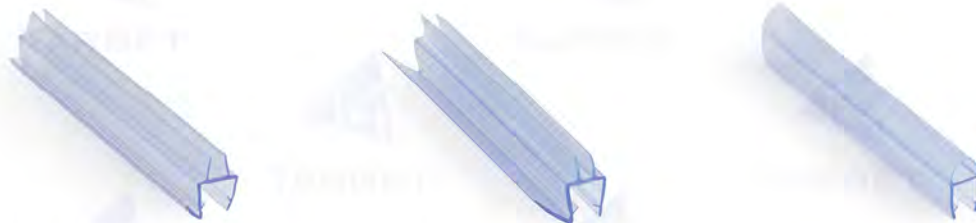
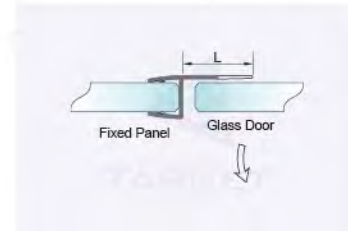
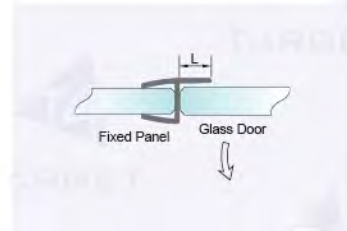
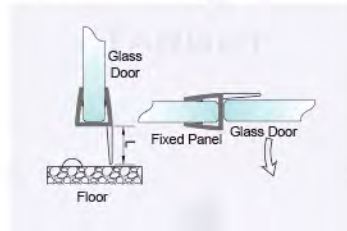

Art. No. PS-7

GLASS THICKNESS	HIGH (H)
6mm	7mm
8mm	7mm
10mm	7mm
12mm	7mm

Art. No. PS-7L

GLASS THICKNESS	HIGH (H)
6mm	8mm
8mm	8mm
10mm	8mm
12mm	8mm

Art. No. PS-11

GLASS THICKNESS	HIGH (H)
6mm	8mm
8mm	8mm
10mm	8mm
12mm	8mm

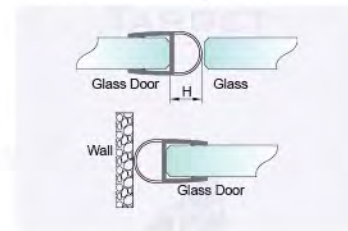
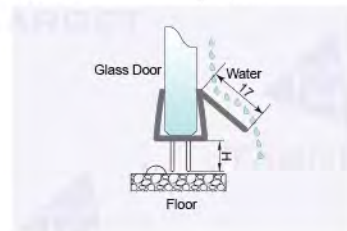
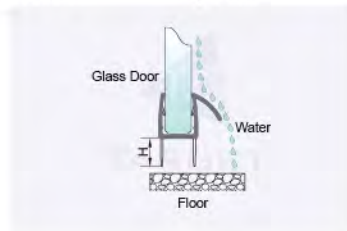

PVC Seal

Glass Thickness
6-12mm Toughened Safety Glass

Material
PVC

Finish
Clear / Matte Black

Standard Length
2200 / 2500mm



Art. No. PS-11AL

GLASS THICKNESS	HIGH (H)
6mm	13mm
8mm	13mm
10mm	13mm
12mm	13mm

Art. No. PS-11C

GLASS THICKNESS	HIGH (H)
6mm	7mm
8mm	7mm
10mm	7mm
12mm	7mm

Art. No. PS-11D

GLASS THICKNESS	HIGH (H)
6mm	8.5mm
8mm	8.5mm
10mm	8.5mm
12mm	8.5mm

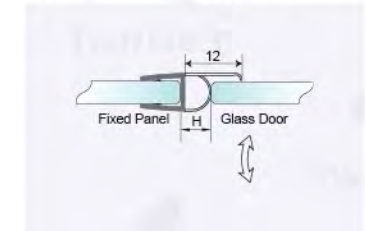
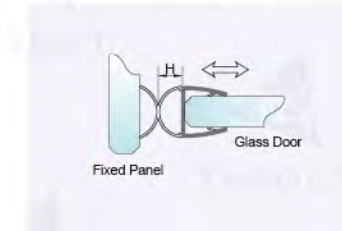
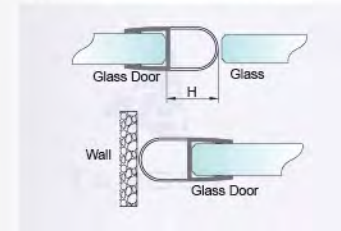

Art. No. PS-11F

GLASS THICKNESS	HIGH (H)
8mm	7mm
10mm	7mm

Art. No. PS-12

GLASS THICKNESS	LENGTH (L)
6mm	8mm
8mm	8mm
10mm	8mm
12mm	8mm

Art. No. PS-13

GLASS THICKNESS	LENGTH (L)
6mm	15mm
8mm	15mm
10mm	15mm
12mm	15mm

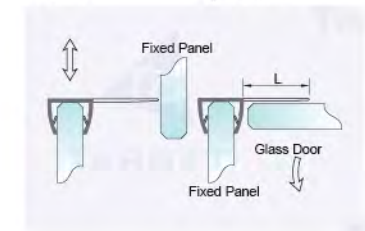
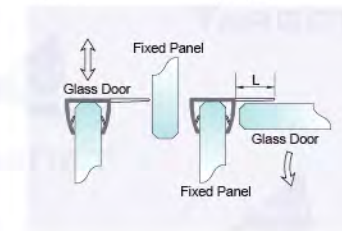
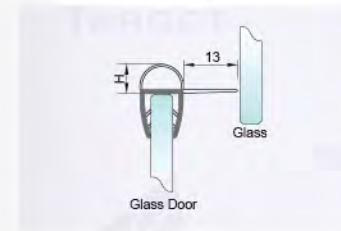

PVC Seal

Glass Thickness
6-12mm Toughened Safety Glass

Material
PVC

Finish
Clear / Matte Black

Standard Length
2200 / 2500mm



Art. No. PS-13C

GLASS THICKNESS	LENGTH (L)
6mm	20mm
8mm	20mm
10mm	20mm
12mm	20mm

Art. No. PS-14

GLASS THICKNESS	LENGTH (L)
6mm	10.6mm
8mm	10.6mm
10mm	10.6mm
12mm	11.6mm

Art. No. PS-15

GLASS THICKNESS	HIGH (H)
8mm	18.5mm
10mm	18.5mm

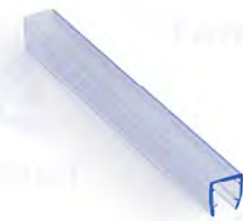
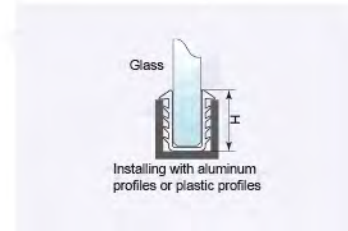
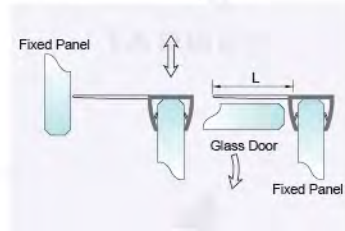

Art. No. PS-16

GLASS THICKNESS	HIGH (H)
6mm	7.5mm
8mm	10.5mm
10mm	11mm
12mm	10.5mm

Art. No. PS-17

GLASS THICKNESS	HIGH (H)
6mm	10.5mm
8mm	11mm
10mm	11.5mm
12mm	12mm

Art. No. PS-18

GLASS THICKNESS	LENGTH (L)
6mm	15mm
8mm	15mm
10mm	15mm
12mm	15mm

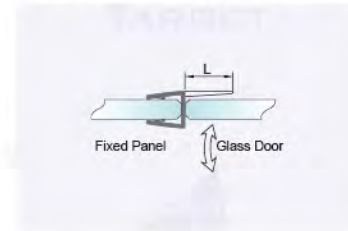
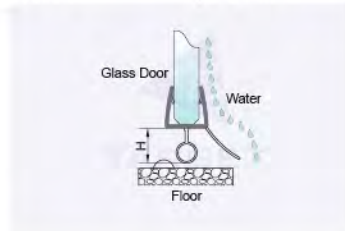

PVC Seal

Glass Thickness
6-12mm Toughened Safety Glass

Material
PVC

Finish
Clear / Matte Black

Standard Length
2200 / 2500mm

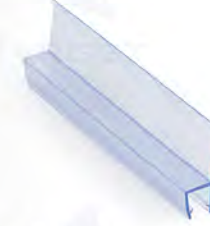

Art. No. PS-18C

GLASS THICKNESS	LENGTH (L)
6mm	18mm
8mm	18mm
10mm	18mm
12mm	18mm

Art. No. PS-19

GLASS THICKNESS	HIGH (H)
6mm	3mm
8mm	6mm
10mm	5mm
12mm	6mm

Art. No. PS-20

GLASS THICKNESS	HIGH (H)
6mm	6mm
8mm	8mm
10mm	8mm
12mm	8mm

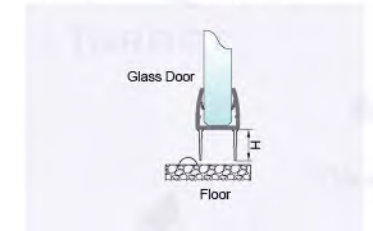
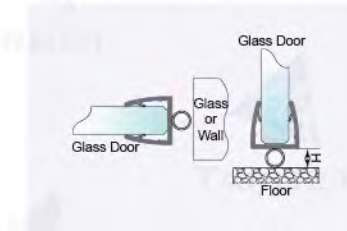
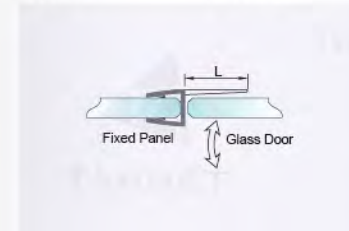

Art. No. PS-21

GLASS THICKNESS	HIGH (H)
6mm	9mm
8mm	9mm
10mm	9mm
12mm	9mm

Art. No. PS-22

GLASS THICKNESS	HIGH (H)
6mm	9mm
8mm	9mm
10mm	9mm
12mm	9mm

Art. No. PS-23

GLASS THICKNESS	HIGH (H)
6mm	22mm
8mm	22mm
10mm	22mm
12mm	22mm

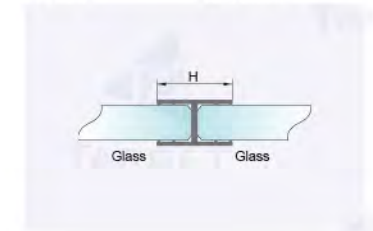
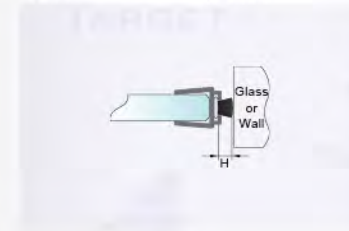

PVC Seal

Glass Thickness
6-12mm Toughened Safety Glass

Material
PVC

Finish
Clear / Matte Black

Standard Length
2200 / 2500mm



Art. No. PS-25

GLASS THICKNESS	LENGTH (L)
6mm	38mm
8mm	34mm
10mm	30mm

Art. No. PS-26

GLASS THICKNESS	HIGH (H)
6mm	18.5mm
8mm	18.5mm
10mm	20mm

Art. No. PS-44

GLASS THICKNESS	HIGH (H)
6mm	14mm
8mm	14mm
10mm	14mm

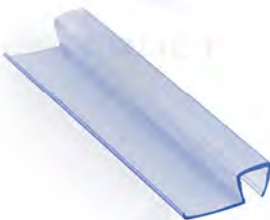
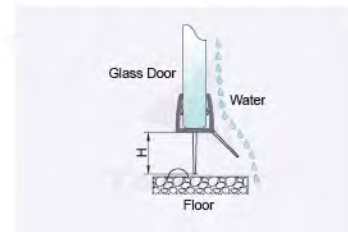
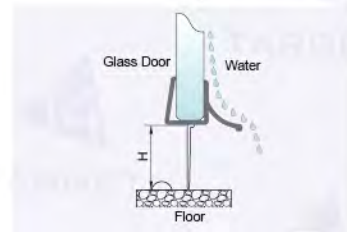
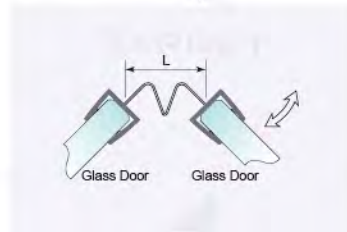

Art. No. PS-27

GLASS THICKNESS	LENGTH (L)
6mm	14mm
8mm	14mm
10mm	14mm
12mm	14mm

Art. No. PS-27S

GLASS THICKNESS	LENGTH (L)
8mm	15mm

Art. No. PS-46

WIDTH (W)	HIGH (H)
12mm	6mm
20mm	8mm

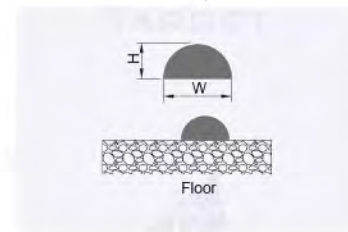
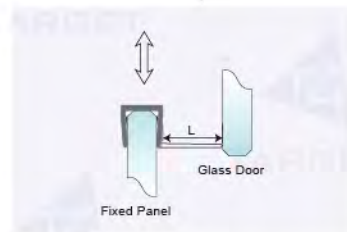
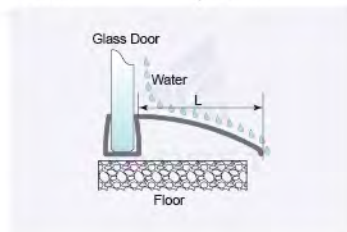

Ultra-Clear PVC Seal



Glass Thickness
6-12mm Toughened Safety Glass

Material
PVC

Finish
Ultra-clear / Matte Black

Standard Length
2200 / 2500mm



Art. No. PS-76

GLASS THICKNESS	HIGH (H)
10mm	11mm

Art. No. PS-116

GLASS THICKNESS	LENGTH (L)
10mm	7.8mm
12mm	7.8mm

Art. No. PS-91

GLASS THICKNESS	LENGTH (L)
10mm	15.5mm

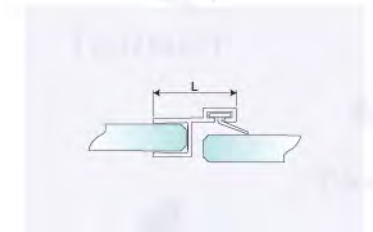
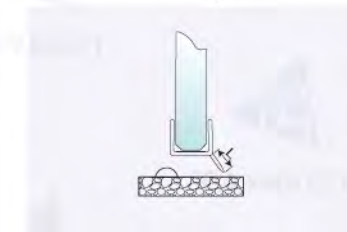
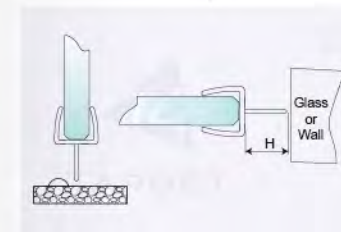

Art. No. PS-92

GLASS THICKNESS	LENGTH (L)
10mm	15.5mm

Art. No. PS-93

GLASS THICKNESS	LENGTH (L)
10mm	15mm

Art. No. PS-94

GLASS THICKNESS	LENGTH (L)
10mm	12mm

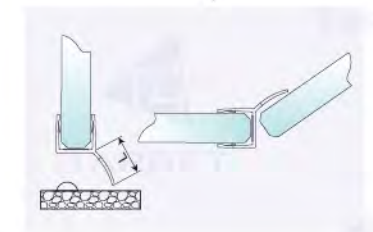
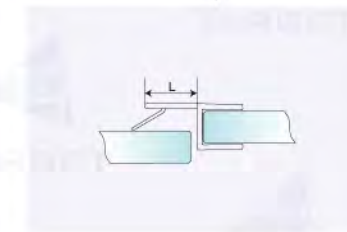
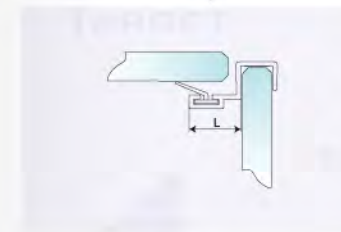

Adhesive seals

Glass Thickness
6-12mm Toughened Safety Glass

Material
PVC

Finish
Clear / Matte Black

Standard Length
2200 / 2500mm



Art. No. PS-44M-A

GLASS THICKNESS	HIGH (H)
8mm	5mm

Art. No. PS-61

GLASS THICKNESS	HIGH (H)
8mm	8mm
10mm	10mm
12mm	12mm
5+5mm	11mm
6+6mm	13mm

Art. No. PS-62M

GLASS THICKNESS	DISTANCE (D)
8mm	8mm
10mm	10mm
12mm	12mm

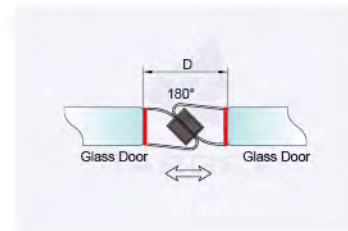
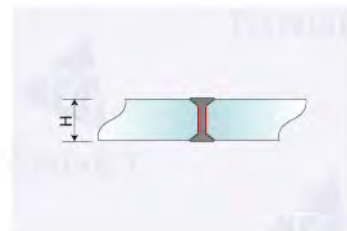
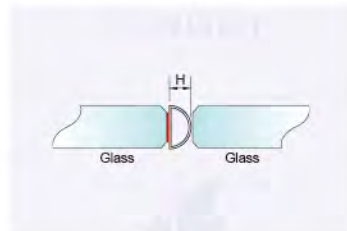

Art. No. PS-64

GLASS THICKNESS	HIGH (H)
3+3mm	11mm

Art. No. PS-72

GLASS THICKNESS	LENGTH (L)
8mm	11mm

Art. No. PS-78

GLASS THICKNESS	HIGH (H1)	HIGH (H2)
8mm	7.8mm	6.3mm

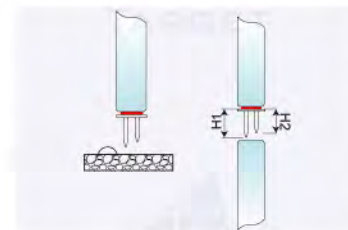
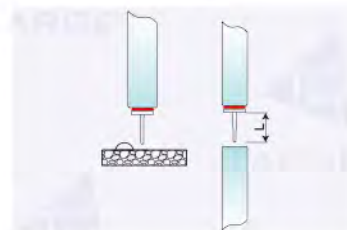
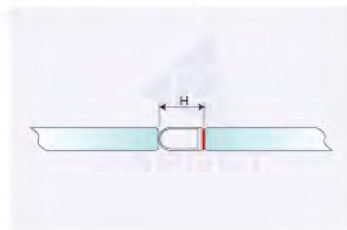

Adhesive seals

Glass Thickness
6-12mm Toughened Safety Glass

Material
PVC

Finish
Clear / Matte Black

Standard Length
2200 / 2500mm



Art. No. PS-107

GLASS THICKNESS	WIDTH (W)
10mm	11mm

Art. No. PS-108

GLASS THICKNESS	WIDTH (W)
10mm	11mm
12mm	13mm

Art. No. PS-136

GLASS THICKNESS	LENGTH (L)
12mm	12mm

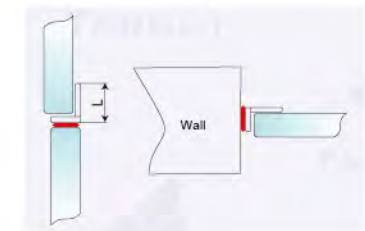
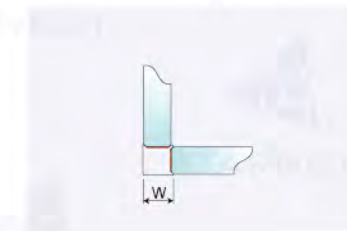
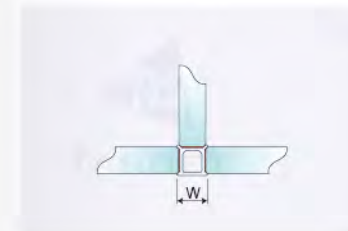

Aluminium Threshold Seals

Mounted directly below the shower door to let the water drain back into the shower stall. Ideal for flat or out-sloping curbs, the rounded low contour of the half round threshold will not harm feet.



Art. No. PS-60AL

WIDTH (W)
15mm

HIGH (H)
9mm

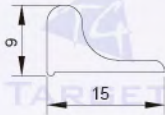

Art. No. PS-59AL

WIDTH (W)
13mm

HIGH (H)
5mm

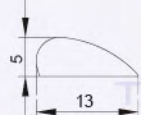

Art. No. PS-135

WIDTH (W)
15mm

HIGH (H)
9mm

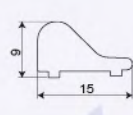

New



Art. No. SF-21

Material
ABS

Finish
Chrome / Black

Art.No. SF-20L / SF-20R

Material
ABS

Finish
Chrome / Black

Art.No. SF-27L / SF-27R

Material
ABS

Finish
Chrome / Black

Art.No. SF-26L / SF-26R

Material
ABS

Finish
Chrome / Black



Sliding Systems OF-A1 Series



Art. No. OF-A-1
Sliding door roller



Art. No. OF-A-2
Fixed Clamp(track to wall)



Art. No. OF-A-3
Fixed Clamp(track to glass)



Art. No. SF-04S
Glass Door Handle



Art. No. OF-A-8
Tube Support



Art. No. OF-A-5L / OF-A-5R
Door Stopper



Art. No. OF-A-10
End Cap



Art. No. OF-A-9
Floor Guide



Art. No. TB-25A
Ø25mm Stainless Steel
Header Support Bar

Specifications

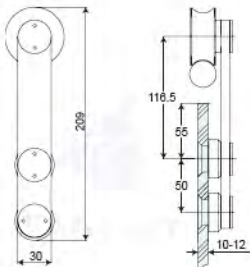

Technical Data

Two kinds connecting for gals holes:

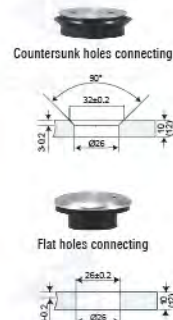

Material	SUS304 / SUS316
Finish	Polished / Satin
Glass Thickness	10-12mm
Glass Fabrication Required	Holes required in fixed panel and door

10-12mm
 100kg
 1200mm
 Tempered Glass

Sliding Systems OF-A11 Series



Art. No. OF-A-11
Sliding door roller



Art. No. OF-A-2
Fixed Clamp(track to wall)



Art. No. OF-A-3
Fixed Clamp(track to glass)



Art. No. SKR-03
Sliding Door Handle



Art. No. OF-A-4B
Double tube to ceiling clamp



Art. No. OF-A-6
Door stopper



Art. No. OF-A-10
End Cap



Art. No. OF-A-9
Floor guide

Specifications

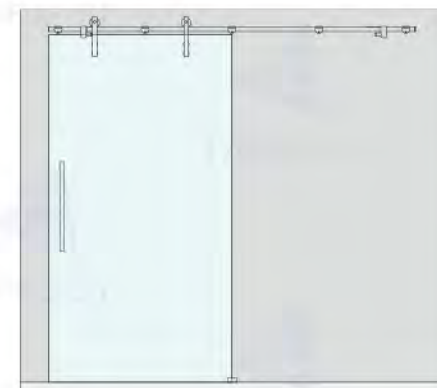
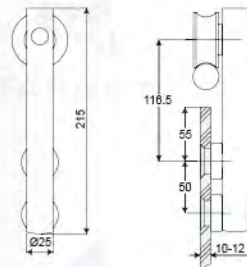

Technical Data

Two kinds connecting for gals holes:

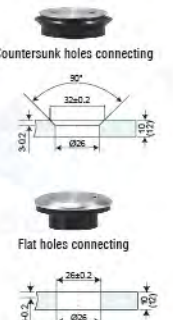

Material	SUS304 / SUS316
Finish	Polished / Satin
Glass Thickness	10-12mm
Glass Fabrication Required	Holes required in fixed panel and door

10-12mm
 100kg
 1200mm
 Tempered Glass

Sliding Systems OF-Y Series



Art. No. OF-Y-1
Sliding door roller



Art. No. OF-Y-2
Clamp fixing for wall



Art. No. OF-Y-3
Clamp fixing for track
The connect with glass



Art. No. SF-04S
Sliding Door Handle



Art. No. OF-Y-8
Tube Support



Art. No. OF-Y-4
Door stopper



Art. No. OF-A-9
Floor guide



Art. No. TB-20S
Ø20 Solid Bar

Specifications

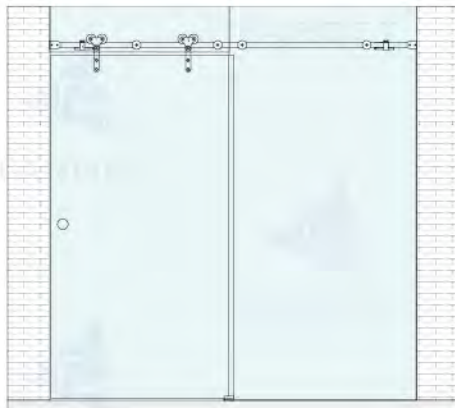
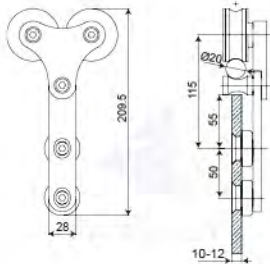

Technical Data

Two kinds connecting for glass holes:

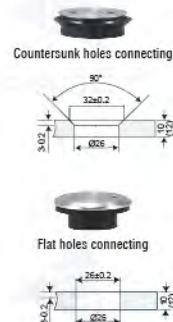

Material	SUS304 / SUS316
Finish	Polished / Satin
Glass Thickness	10-12mm
Glass Fabrication Required	Holes required in fixed panel and door



Sliding Systems OF-A1B Series



Art. No. OF-A-1B
Sliding door roller



Art. No. SF-2H
Clamp fixing for track and glass



Art. No. OF-A-14
Clamp fixing for wall



Art. No. SKR-04
Sliding Door Handle



Art. No. OF-A-8
Tube Support



Art. No. OF-A-10
End Cap



Art. No. OF-A-9
Floor Guide



Art. No. OF-A-7
Door stopper

Specifications

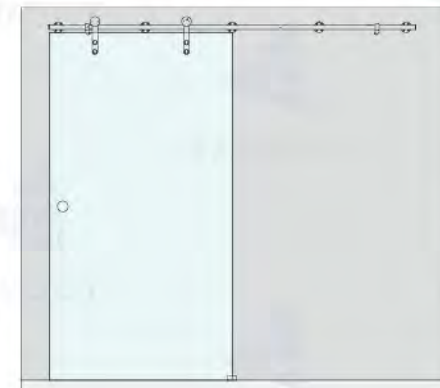
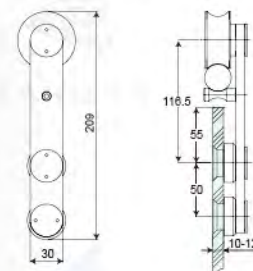

Technical Data

Two kinds connecting for glass holes:

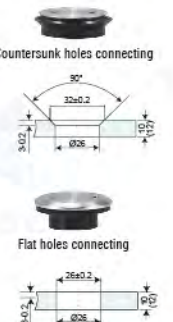

Material	SUS304 / SUS316
Finish	Polished / Satin
Glass Thickness	10-12mm
Glass Fabrication Required	Holes required in fixed panel and door



Pivot Series OF-C System



Art. No. OF-C-2
Top Pivot



Art. No. OF-C-3
Bottom Pivot



Art. No. LHL-071
Lever Lockset



Art. No. OF-C-8
Ceiling Pivot



Art. No. OF-C-7
Floor Pivot

Material	SUS304 / SUS316
Finish	Polished / Satin
Glass Thickness	10-12mm
Glass Fabrication Required	Holes required in fixed panel and door

Technical Data

Two kinds connecting for glass holes:

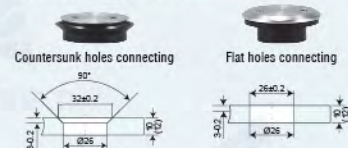

Pivot Series OF-R System



Art. No. OF-R-1
Curve Top Pivot
Overpanel/sidelight connector
with pivot
For glass 10-12mm



Art. No. OF-R-2
Upper Pivot
Pivot pole with single point
For glass 10-12mm



Art. No. OF-R-3
Bottom Pivot
Pivot pole with single point
For floor guide or floorspring
For glass 10-12mm



Art. No. OF-R-4
Pivot For Overpanel
For glass 10-12mm

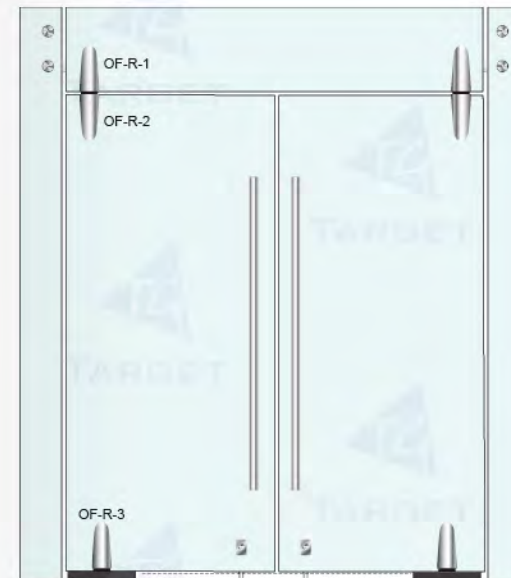

Pivot Series OF-D Systems



Art. No. OF-D-1
Curve Top Pivot



Art. No. OF-D-2
Pivot For Overpanel



Art. No. OF-D-3
Overpanel/sidelight connector



Art. No. OF-D-4
Overpanel/sidelight connector with stopper inside



Art. No. OF-D-5
Stopper for ceiling mounting



Art. No. OF-D-6
Stopper for overpanel mounting



Art. No. OF-C-1
Curve Top Pivot



Art. No. OF-C-5
Overpanel/sidelight connector



Art. No. OF-C-6
Overpanel pivot for glass with wall fixing

Art. No. OF-E
Connecting Rod

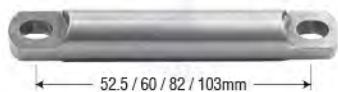

52.5 / 60 / 82 / 103mm

Art. No. OF-T
installation tool



Glass Corner Connector



Art. No. OF-E-1
Glass / Glass Corner Connector
Connection for connecting glass and glass
Two direction sides can adjust angle



Art. No. OF-E-2
Glass / Wall Corner Connector
Connection for connecting wall and glass
Two direction sides can adjust angle



Art. No. OF-E-3
Glass / Wall Corner Connector
Connection for connecting wall and glass
One direction side can adjust angle



Art. No. OF-E-4
Clamping Connector
Connection for connecting glass and glass
four directions sides can adjust angle



Art. No. OF-E-6
Clamping Connector
Connection for connecting wall and glass
Two directions sides can adjust angle



Art. No. OF-E-5
Glas/ Wall Corner Connector
Connection for connecting wall and glass.

GLASS PREPARATION

For glass/glass connection
For 10mm and 12mm toughened glass

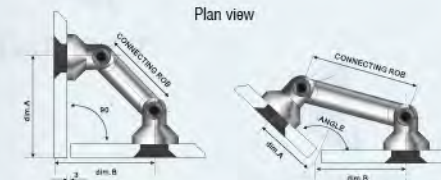

Technical Data

Two kinds connecting for glass holes:

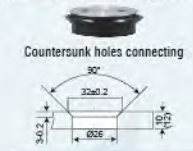

Use: two kinds options of glass connection, mainly used for clamping glass.

Canopy Systems



Art. No. OF-Q-1
Lower Fastening Point

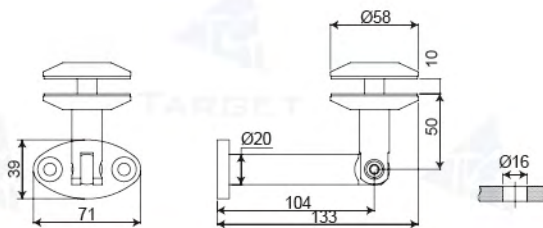

Material	SUS304 / SUS316
Finish	Satin
Glass thickness	12-18mm
Features	Wall-mounted connector for glass

Canopy Systems

Art. No. OF-Q-2
Point Fitting

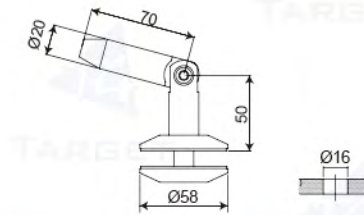

Material	SUS304 / SUS316
Finish	Satin
Glass thickness	12-18mm
Features	Glass-mounted connector with 14mm junction pin

Art. No. OF-Q-3
Upper Fastening Point

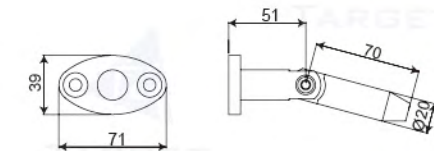

Material	SUS304 / SUS316
Finish	Satin
Features	Wall-mounted connector with 14mm junction pin

Art. No. OF-Q-4
Connecting Rod
Standard Length: 1000mm/1200mm



Material	SUS304 / SUS316
Finish	Satin
Features	Tie rod 14mm with threaded end, M10 right and M10 left



Office Glass fitting Series

Sliding Systems SL-W30 Series





Art. No. SL-W30
Roller

Material	SUS304 / SUS316
Finish	Polished / Satin
Glass thickness	8-10mm
Glass Fabrication Required	Holes required in fixed panel and door

 8-10mm

 80kg

 1000mm

 Tempered Glass



Art. No. SF-04S
Glass Door Handle



Art. No. OF-A-9
Floor Guide



Art. No. SL-003
Door Stopper



Art. No. SL-020
Header Support Bar



Art. No. SL-024L/R
End Cap

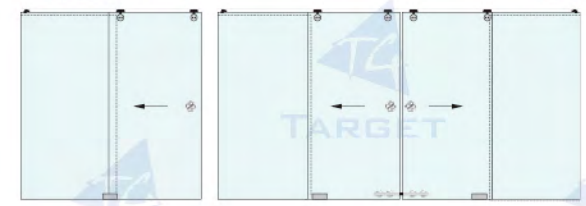
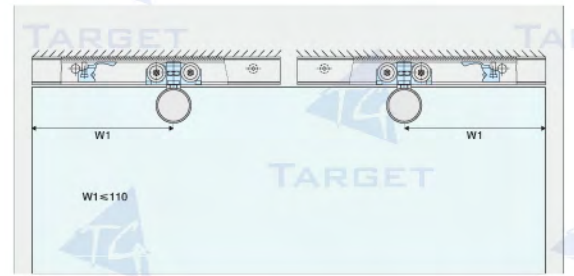
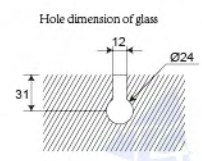

Sliding Systems SL-001 Series



Art. No. SL-001
Roller

Material	SUS304 / SUS316
Finish	Polished / Satin
Glass thickness	8-10mm
Glass Fabrication Required	Holes required in fixed panel and door

8-10mm

80kg

1000mm

Tempered Glass



Art. No. SKR-04
Glass Door Handle



Art. No. OF-A-9
Floor Guide



Art. No. SL-003
Door Stopper



Art. No. SL-004
End Cap

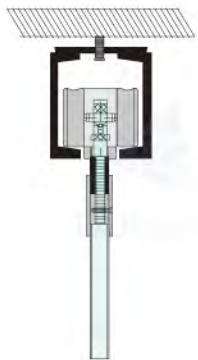

Hole dimension of glass

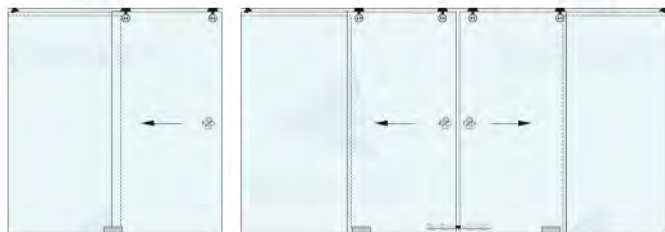
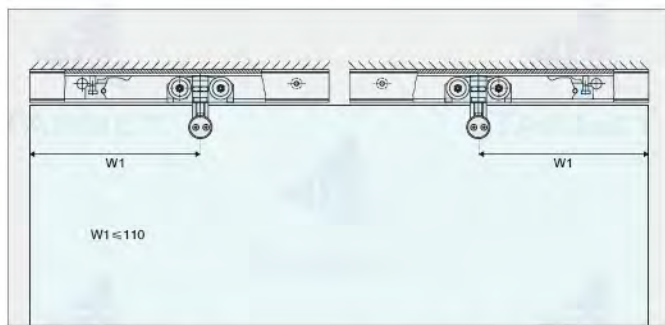
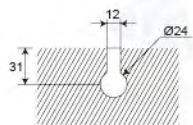

Sliding Systems Accessories

Art. No. SL-007
Fixed Clamp (track to glass)

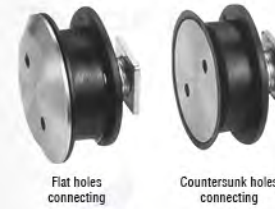

Art. No. SL-008
wall support

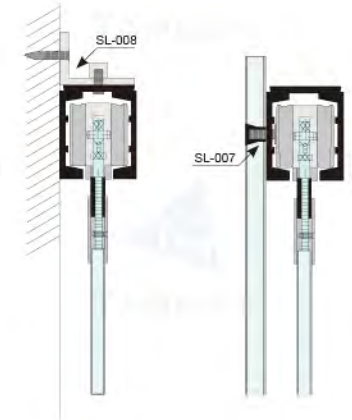

Art. No. SL-010



Art. No. SL-011



Art. No. SL-012

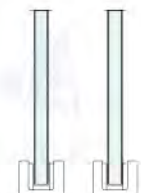
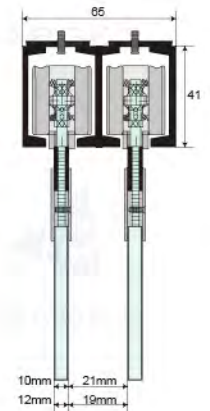
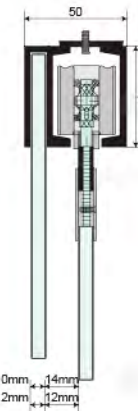

Sliding Systems SL-002B Series

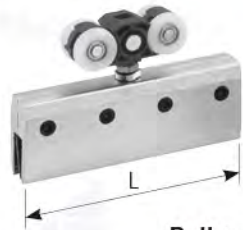

Roller

Art. No.	L	Max Weight
SL-002B	75mm	40kgs
SL-002B-M	120mm	80kgs
SL-002B-H	150mm	120kgs

Material Aluminium
Finish Silver / Satin Nickel
Glass Thickness 8-12mm
Glass Fabrication Required No holes required in glass



Art. No. SKR-02
Glass Door Handle



Art. No. OF-A-9
Floor Guide



Art. No. SL-003
Door Stopper



Art. No. SL-004
End Cap

Sliding Systems SL-200B Series



Roller

Art. No.	L	Max Weight
SL-200B	75mm	40kgs
SL-200B-M	120mm	80kgs
SL-200B-H	150mm	120kgs

Material Aluminium
Finish Silver/Satin Nickel
Glass Thickness 8-12mm
Glass Fabrication Required No holes required in glass



Art. No. SKR-03
Glass Door Handle



Art. No. OF-A-9
Floor Guide



Art. No. SL-003B
Door Stopper

Installing Ways



Glass door assembly drawing

Glass door assembly drawing



Art. No. SL-016

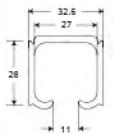

Art. No. SL-016-1

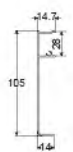

Art. No. SL-016-3

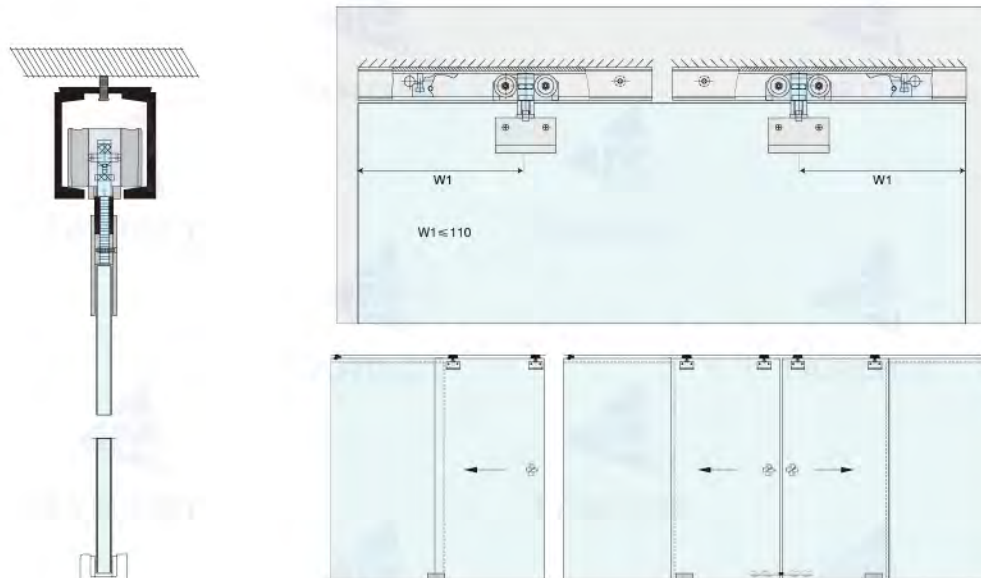
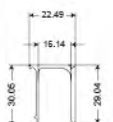

Sliding Barn Door



A barn door is more than a point of entry. A barn door offers a simple yet beautiful way to take the style of your home up a notch.

Material	Q235B (Iron)
Finished	Black
Door Thickness	40-45mm
Loading Capacity	100kg
Standard Track Length	2000mm

Art. No. OF-W-11



2 Meter includes:

- 2 x Rollers
- 2 x End Bumpers
- 2 x Anti-derailer
- 5 x Spacers (for installation between the wall and the rail brackets)
- 1 x Floor guide
- 4 x 500mm Rail

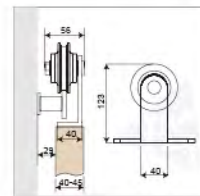
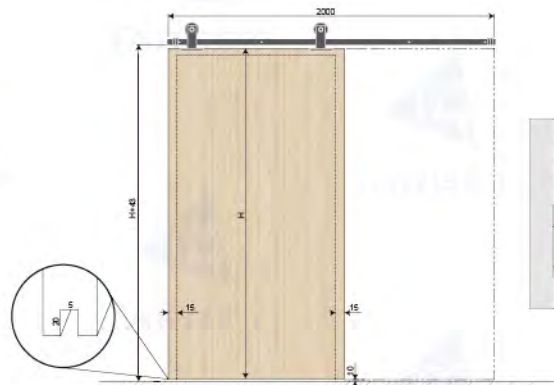

- For application of single or multiple sliding doors
- Fine powder coated surface ensures anti-corrosion and years of beauty and longevity
- Balance wheel for extra stabilizing
- Easy installation, smooth and quiet operation, long durability
- Suitable for residential and commercial environment such as hotel and office

Sliding Barn Door



A barn door is more than a point of entry. A barn door offers a simple yet beautiful way to take the style of your home up a notch.

Material	Q235B (Iron)
Finished	Black
Door Thickness	40-45mm
Loading Capacity	100kg
Standard Track Length	2000mm

Art. No. OF-W-12



2 Meter includes:

- 2 x Rollers
- 2 x End bumpers
- 2 x Anti-derailer
- 5 x Spacers (for installation between the wall and the rail brackets)
- 1 x Floor guide
- 4 x 500mm Rail

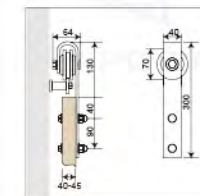
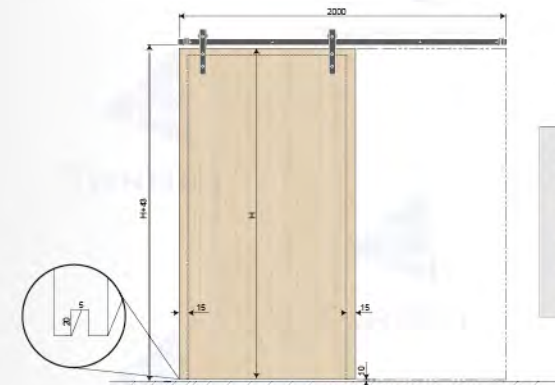

- For application of single or multiple sliding doors
- Fine powder coated surface ensures anti-corrosion and years of beauty and longevity
- Balance wheel for extra stabilizing
- Easy installation, smooth and quiet operation, long durability
- Suitable for residential and commercial environment such as hotel and office

Sliding Barn Door



Our barn doors add a distinctive and interesting element to your home, and not only serve as doors for space partition but also present infinite design beauty.

Material	Q235B (Iron)
Finished	Black
Door Thickness	40-45mm
Loading Capacity	100kg
Standard Track Length	2000mm

Art. No. OF-W-13



2 Meter includes:

- 2 x rollers
- 2 x end bumpers
- 2 x anti-derailer
- 5 x spacers (for installation between the wall and the rail brackets)
- 1 x floor guide
- 4 x 500mm rail

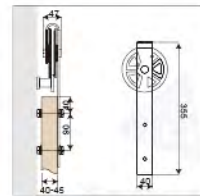
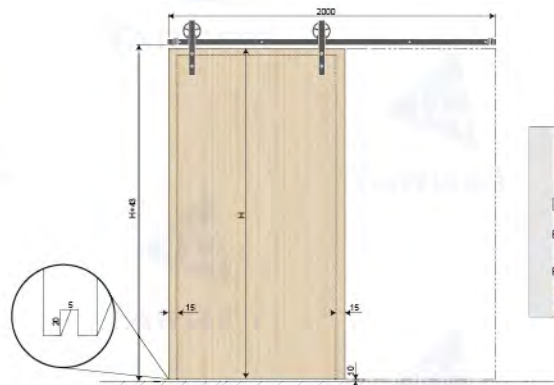

- For application of single or multiple sliding doors
- Fine powder coated surface ensures anti-corrosion and years of beauty and longevity
- Balance wheel for extra stabilizing
- Easy installation, smooth and quiet operation, long durability
- Suitable for residential and commercial environment such as hotel and office

Sliding Barn Door



This is simple wood door hardware at its best. The door rollers render them smooth and silent so barn doors can be maneuvered effortlessly.

Material	SUS304
Finished	Satin
Door Thickness	40-45mm
Loading Capacity	100kg
Standard Track Length	2000mm

Art. No. OF-AO



2 Meter includes:

- 2 x Rollers
- 2 x End Cover
- 2 x Door Stopper
- 5 x Fixed Clamp (rail to wall)
- 1 x Floor Guide
- 1 x 2m Rail

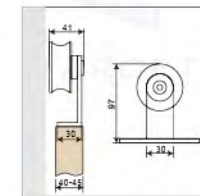
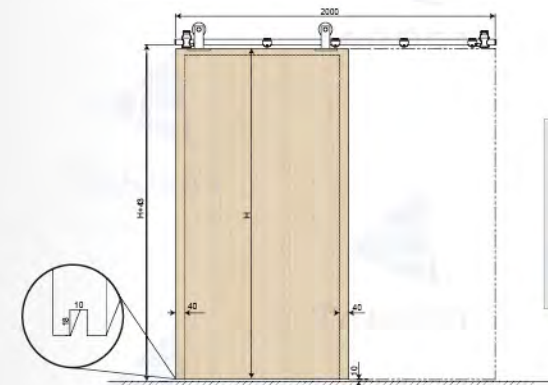

- For application of single or multiple sliding doors
- Balance wheel for extra stabilizing
- Easy installation, smooth and quiet operation, long durability
- Suitable for residential and commercial environment such as hotel and office

Sliding Systems SL-501 Series



Art. No. SL-501
Bottom Roller



Art. No. SL-502
Bottom Track



Art. No. SL-505
Door Stopper



Art. No. SL-504
Clamp Roller



Art. No. SL-503
Header Support Bar



Art. No. SL-506
End Cover

Material	SUS304 / SUS316
Finish	Polished / Satin
Glass Thickness	10-12mm
Glass Fabrication Required	Holes required in door

Sliding Door Handle

Art. No. SKR-01
Sliding Door Handle

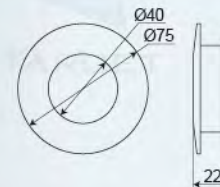

Material	SUS304
Glass Thickness	8-12mm
Finish	Polished / Satin / Matte Black

Art. No. SKR-02
Sliding Door Handle

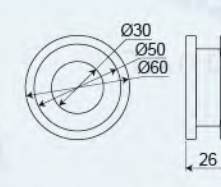

Material	SUS304
Glass Thickness	8-10mm
Finish	Polished / Satin / Matte Black

Art. No. SKR-03
Sliding Door Handle

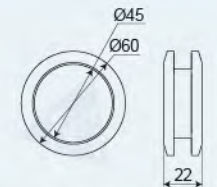

Material	SUS304
Glass Thickness	8-10mm
Finish	Polished / Satin / Matte Black

Art. No. SF-04S
Sliding Door Handle

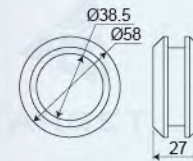

Material	SUS304
Glass Thickness	8-10mm
Finish	Polished / Satin / Matte Black

Art. No. SKR-04
Sliding Door Handle

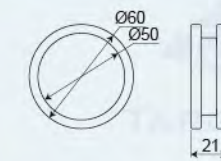

Material	SUS304
Glass Thickness	8-10mm
Finish	Polished / Satin / Matte Black

Art. No. SKR-07
Sliding Door Handle

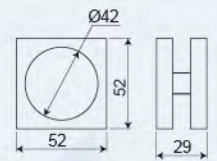
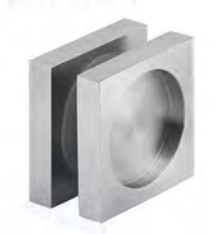

Material	SUS304
Glass Thickness	8-10mm
Finish	Polished / Satin / Matte Black

Sliding Door Handle

Art. No. SKR-05

Sliding Door Handle

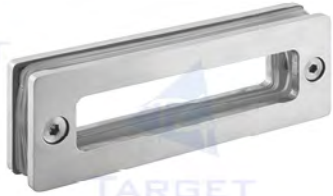

Material SUS304
Glass Thickness 8-10mm
Finish Polished / Satin / Matte Black

Art. No. SKR-06

Sliding Door Handle

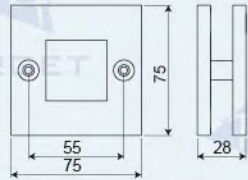

Material SUS304
Glass Thickness 8-10mm
Finish Polished / Satin / Matte Black

Art. No. SK-41

Sliding Door Handle

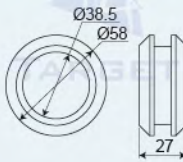

Material Aluminium
Glass Thickness 8-10mm
Finish Satin / Silver / Matte Black

Art. No. SKR-39

Sliding Door Handle With Self Adhesive Tape

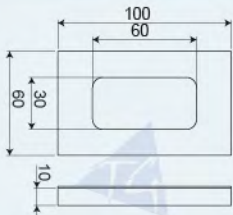

Material Aluminium
Finish Satin / Silver / Matte Black

Art. No. SKR-40

Sliding Door Handle With Self Adhesive Tape

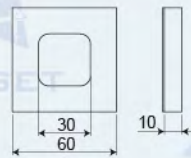

Material Aluminium
Finish Satin / Silver / Matte Black

Art. No. SKR-07S

Sliding Door Handle With Self Adhesive Tape

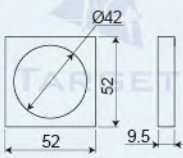
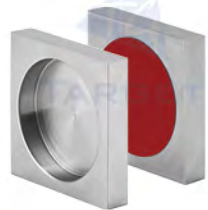

Material SUS304 / Aluminium
Finish Satin / Silver / Matte Black

Glass Range of Sliding And Stacking Series

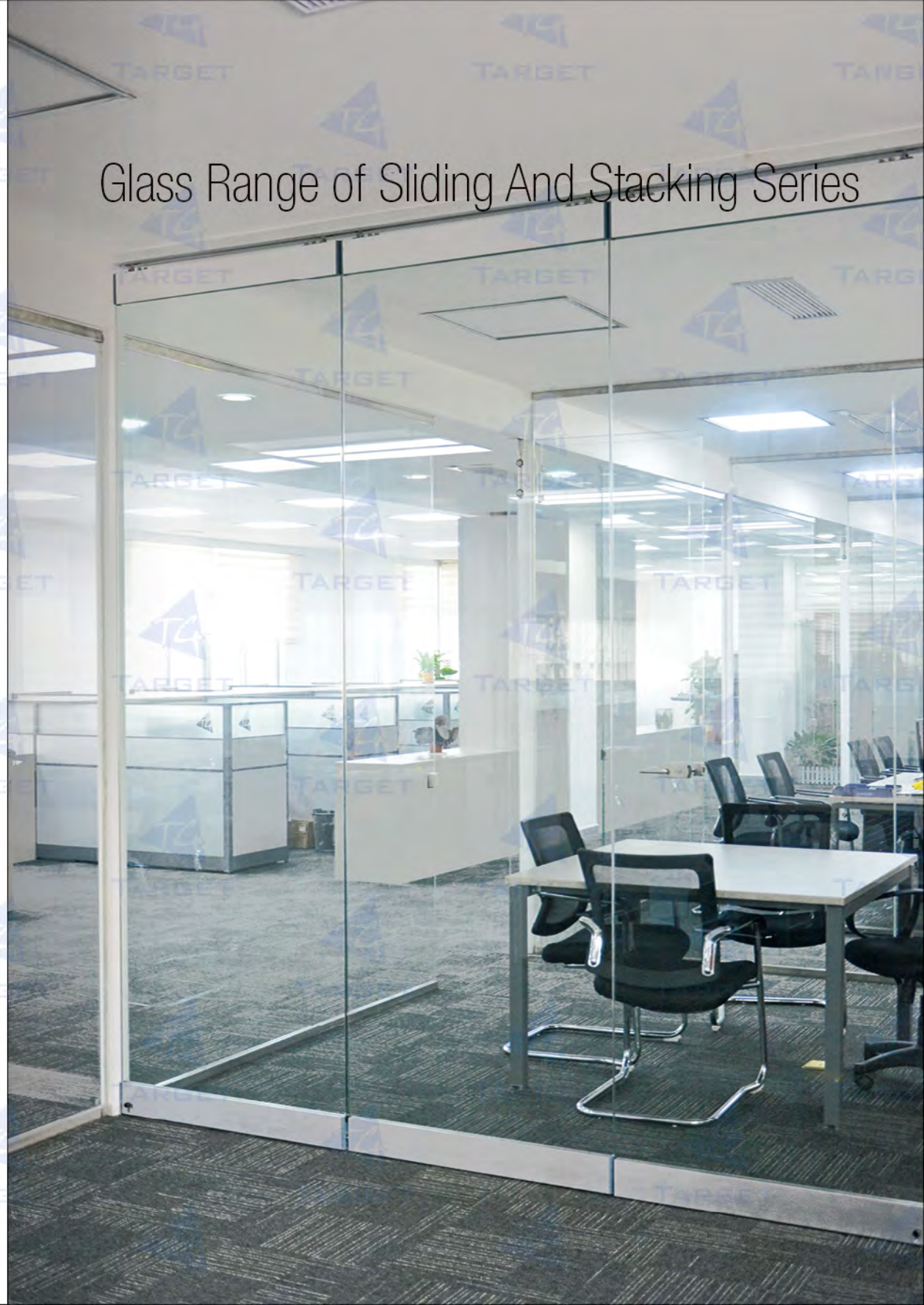

PK-001 SERIES



SLIDE AND STACK GLASS PANEL SYSTEM features a comprehensive combination of aluminium top track that facilitates flexibility in design layout.

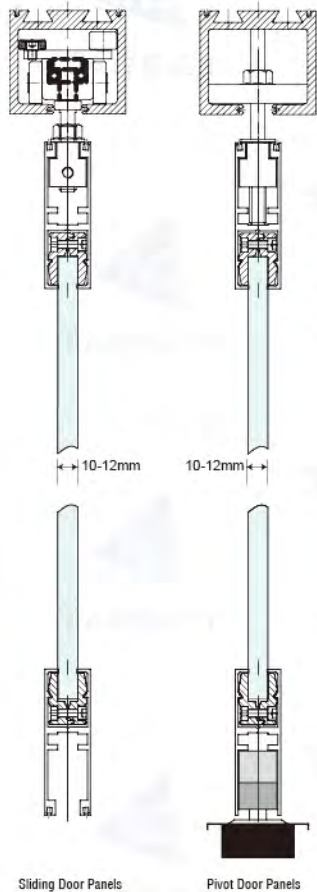

- Sliding stackable glass doors weighing up to 150 kg.
- Glass door width up to 1250mm and height up to 3500mm.
- No glass cut-outs needed.
- Installed without a bottom guide channel.
- Simple installation and immense flexibility thanks to a modular, snap-fitting track system.
- Specially designed for heavy-duty doors that call for a high degree of quality and precision.
- Smooth running and highly durable.



PK-001 SERIES

SLIDING AND STACKING SYSTEMS complement both maximum shopfront area and close customer proximity as you have a choice of various parking space layout to dock the individual frameless glass panels.

Examples Parking Areas

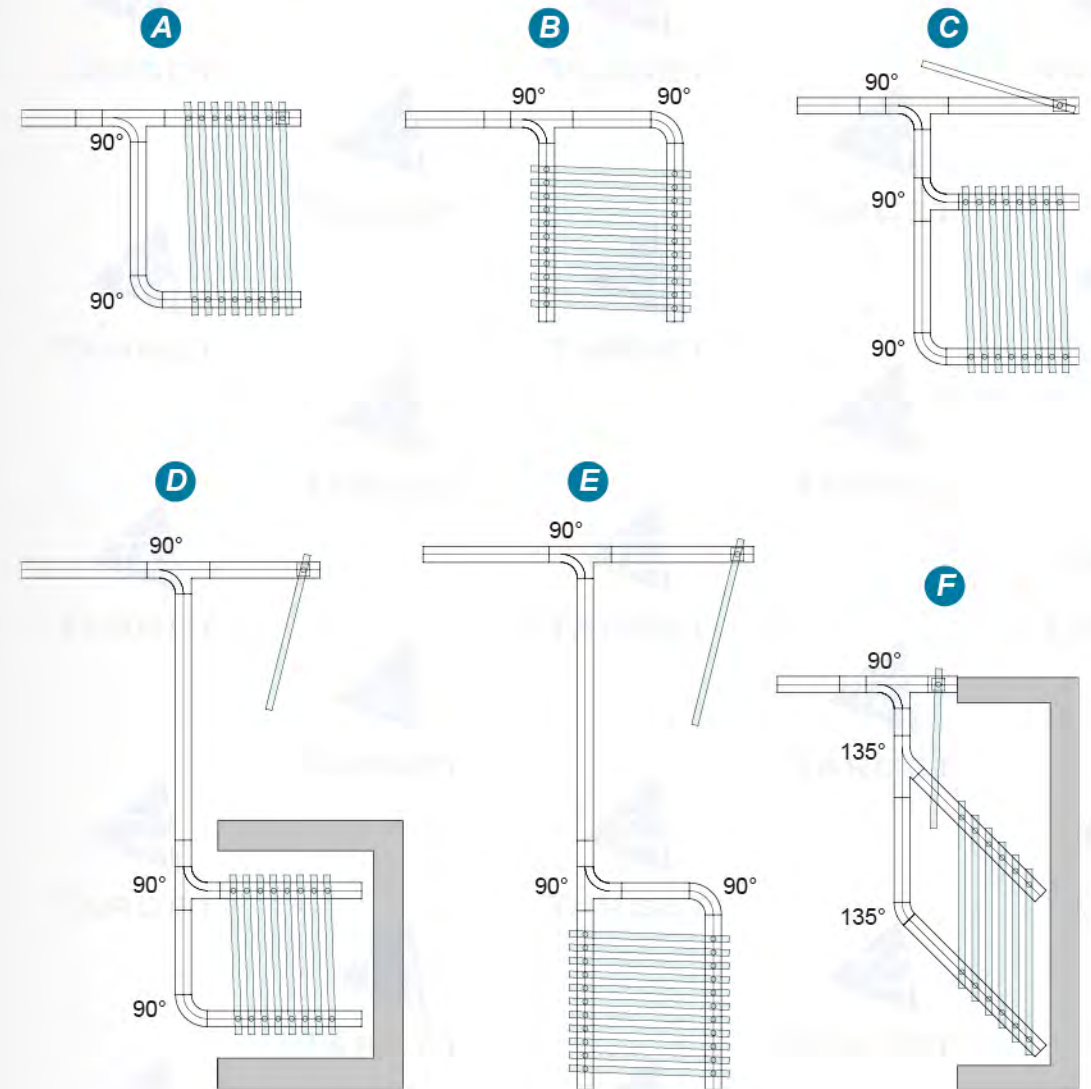

Examples Parking Areas

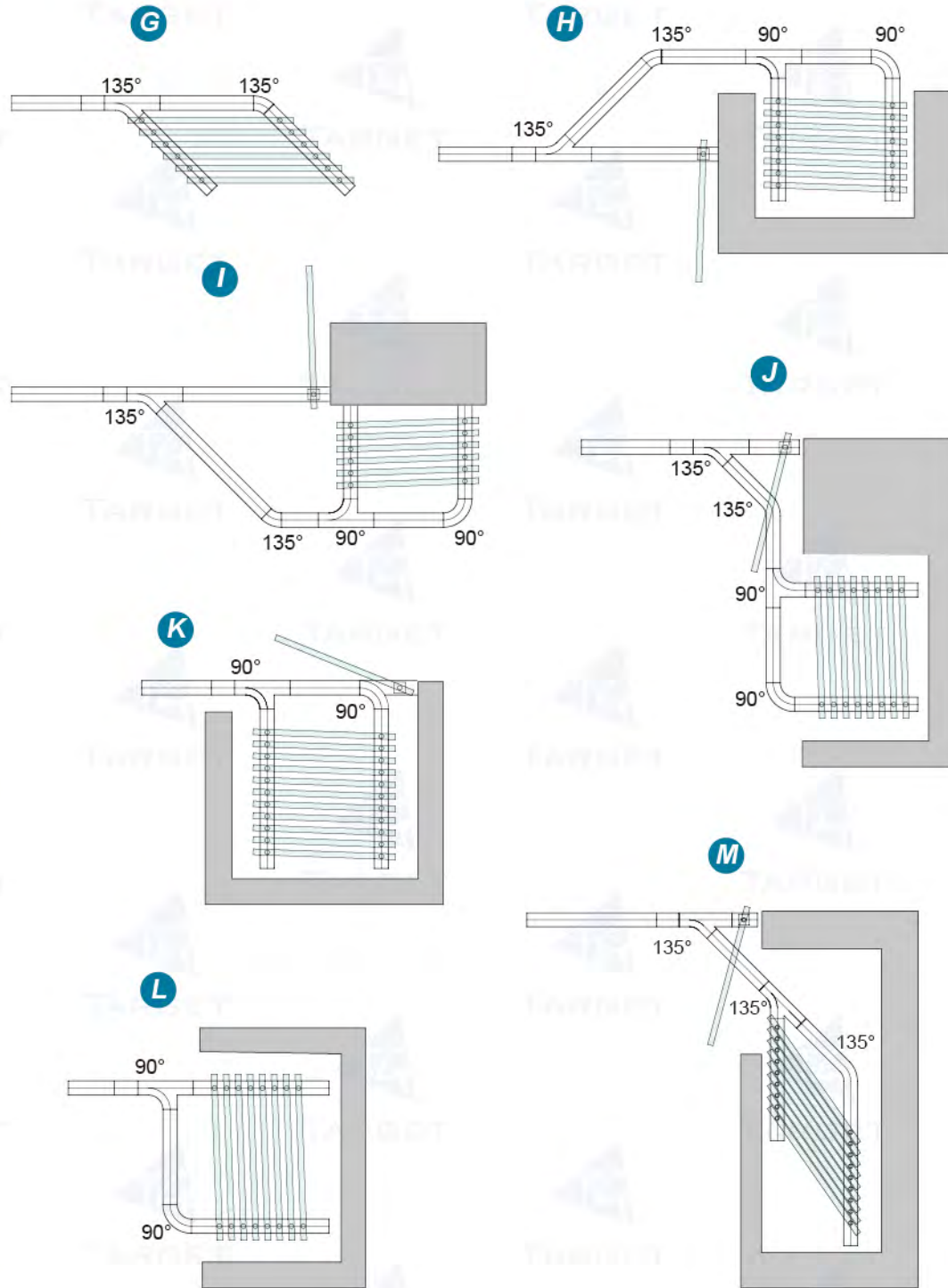

SW-T Series

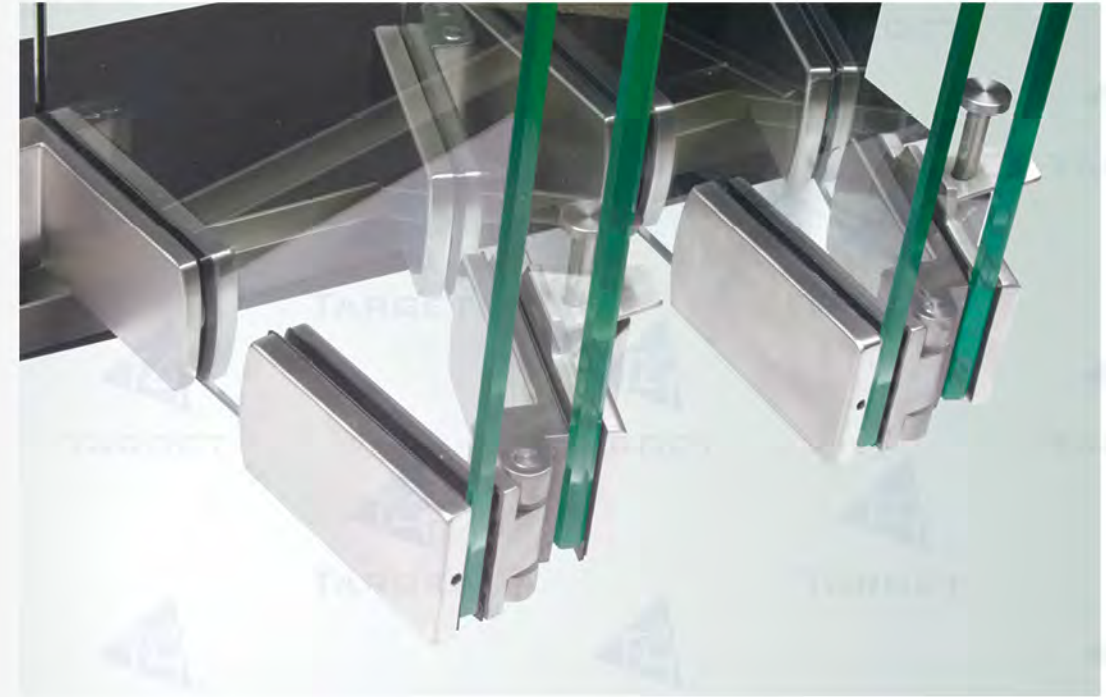

This design originates from European design. This system makes for easier installation and adjustments after installation.

Quality

All metal components of the rollers and hinges are Stainless Steel to hold up to any environment. The rollers have ball bearing centers with nylon perimeter to give a lifetime of smooth operation.

The rollers ride in an Aluminium track at the top that is anodized satin. The guide rollers at the bottom of the doors ride in an Aluminium track incorporated into the threshold.

Practical

The system can be locked with a slide bolt or key turn and all components are corrosion resistant with satin finish. The hanger wheels are fitted with double sealed precision stainless steel bearings to ensure long life and smooth operation.



Folding Systems SW-T Series



Art. No. SW-02T
Folding Door Roller



Art. No. SW-03T
Folding Door Roller



Art. No. SW-04T
Clip with Guide to Floor



Art. No. SW-05T
Clip With Guide to Floor



Art. No. SW-06T
Top Rail With Anchor



Art. No. SW-07T
Glass Door Bolt



Art. No. SW-08T
Glass Door Hinge Without Guide



Art. No. SW-10T
Left/Right Lower Fixing Clip



Art. No. SW-09T
Glass to Wall Hinge



Folding Systems SW-T series



Art. No. SL-010
Upper Track



Art. No. SFL-101AL
Bottom Track A



Art. No. SFL-102
Bottom Track B



Art. No. SW-01B
Door Lock Glass to Wall



Art. No. SW-01A
Door Lock Glass to Glass

Formula to calculate the width of the doors
 F: Full length
 P: Number of glass
 S: Glass width
 $S = (F - 30) / P$
 $S1 = S + 40$
 $S2 = S - 20$

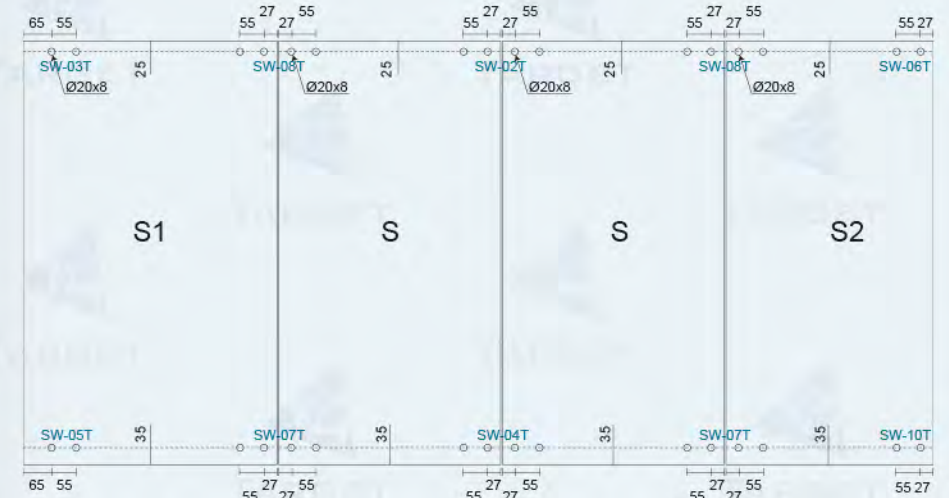
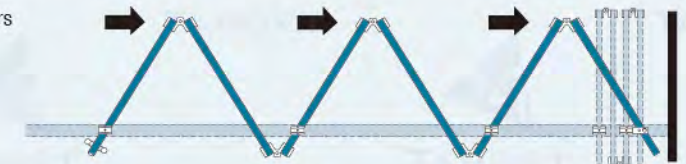

Folding Systems SL-W Series



Art. No. SL-W40
Folding Door Roller



Art. No. SW-20T
Glass to Glass Hinge



Art. No. SW-21T
Glass to Wall Hinge



Art. No. SF-04S
Glass Door Handle



Art. No. APF-021C
Door Lock



Art. No. DP002
Dust Proof

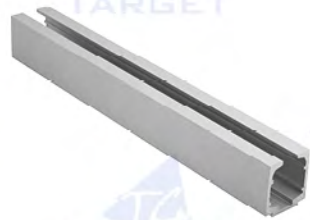

Art. No. SL-010
Upper Track

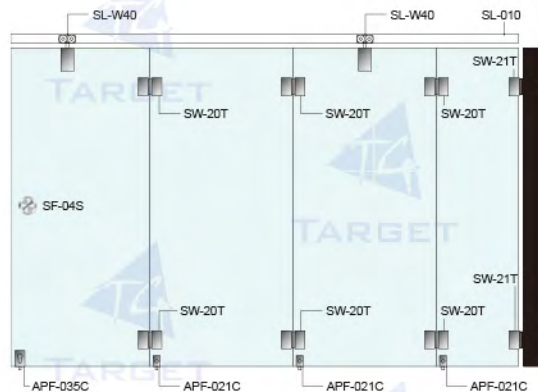
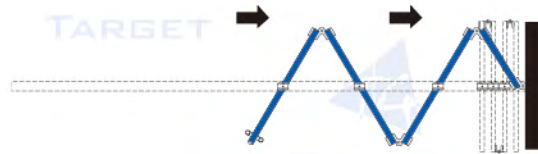

- 8-12mm
- 70kg
- 2500mm
- Tempered Glass

Lever Lockset Series



Lever Lockset

Art. No. LHL-080

Lever Lockset (Glass to Wall)



Art. No. LHL-080D

Lever Lockset (Glass to Wall)

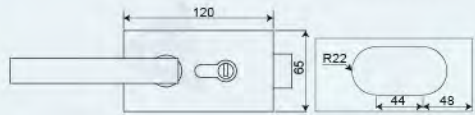

Material | SUS304 / Aluminum
Finish | Satin / Silver / Matte Black

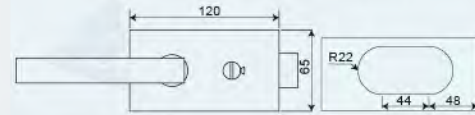

Material | SUS304 / Aluminum
Finish | Satin / Silver / Matte Black

Art. No. LHL-090

Lever Lockset (Glass to Wall)



Art. No. LHL-090D

Lever Lockset (Glass to Wall)

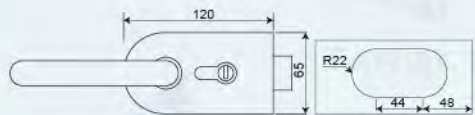

Material | SUS304 / Aluminum
Finish | Satin / Silver / Matte Black

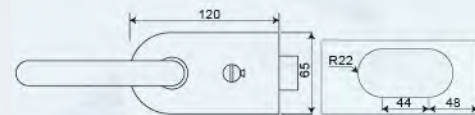

Material | SUS304 / Aluminum
Finish | Satin / Silver / Matte Black

Lever Lockset

Art. No. LHL-050

Lever Lockset (Glass to Wall)

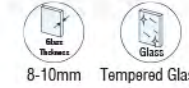

Art. No. LHL-051-M

Lever Lockset (Glass to Wall)



Magnetic

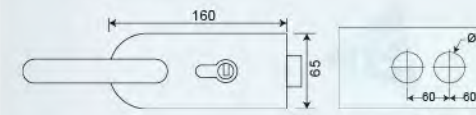

Material | SUS304 / Aluminum
Finish | Satin / Silver / Matte Black

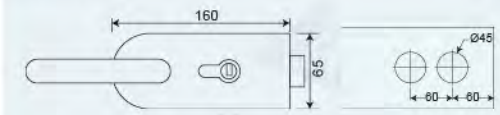

Material | SUS304 / Aluminum
Finish | Satin / Silver / Matte Black

Art. No. LHL-050D

Lever Lockset (Glass to Wall)

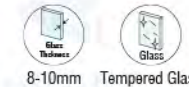

Art. No. LHL-051

Lever Lockset (Glass to Glass)

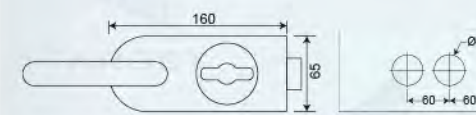

Material | SUS304 / Aluminum
Finish | Satin / Silver / Matte Black

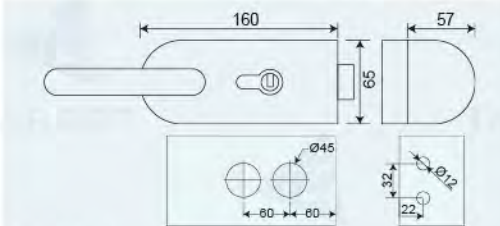

Material | SUS304 / Aluminum
Finish | Satin / Silver / Matte Black

Lever Lockset

Art. No. LHL-050F

Lever Lockset (Glass to Wall)



Art. No. LHL-052

Lever Lockset (Glass to Glass)

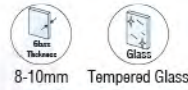

Material	SUS304 / Aluminum
Finish	Satin / Silver / Matte Black

Material	SUS304 / Aluminum
Finish	Satin / Silver / Matte Black

Optional Lever Handle



Art. No. LH-01



Art. No. LH-02



Art. No. LH-03



Art. No. LH-04



Art. No. LH-05



Art. No. LH-08

Lever Lockset

Art. No. LHL-070

Lever Lockset (Glass to Wall)

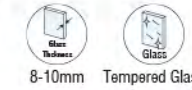

Art. No. LHL-070B

Lever Lockset (Glass to Wall)



Material	SUS304 / Aluminum
Finish	Satin / Silver / Matte Black

Material	SUS304 / Aluminum
Finish	Satin / Silver / Matte Black

Art. No. LHL-070D

Lever Lockset (Glass to Wall)



Art. No. LHL-071

Lever Lockset (Glass to Glass)



Material	SUS304 / Aluminum
Finish	Satin / Silver / Matte Black

Material	SUS304 / Aluminum
Finish	Satin / Silver / Matte Black

Lever Lockset

Art. No. LHL-060

Lever Lockset (Glass to Wall)

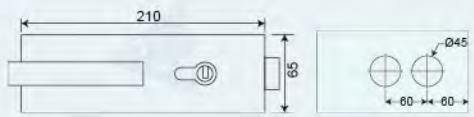

Material | SUS304 / Aluminum
Finish | Satin / Silver / Matte Black

Art. No. LHL-060B

Lever Lockset (Glass to Wall)

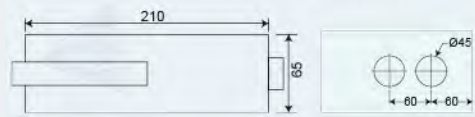
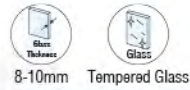

Material | SUS304 / Aluminum
Finish | Satin / Silver / Matte Black

Art. No. LHL-060D

Lever Lockset (Glass to Wall)

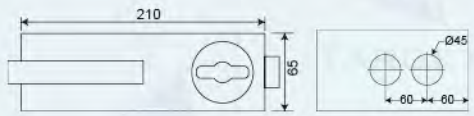

Material | SUS304 / Aluminum
Finish | Satin / Silver / Matte Black

Art. No. LHL-061

Lever Lockset (Glass to Glass)

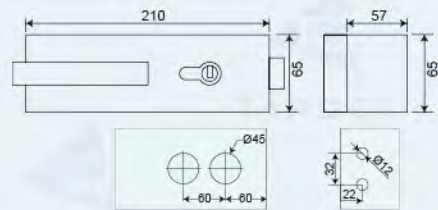

Material | SUS304 / Aluminum
Finish | Satin / Silver / Matte Black

Lever Lockset

Art. No. LHL-001

Lever Lockset (Glass to Wall)

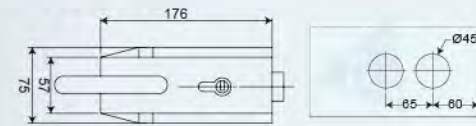
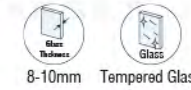

Material | Zinc Alloy
Finish | Chrome / Satin Nickel / Matte Black

Art. No. LHL-002

Lever Lockset (Glass to Glass)

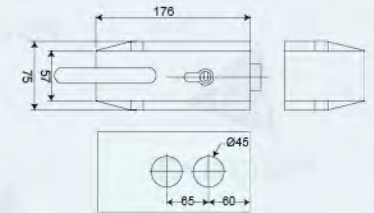

Material | Zinc Alloy
Finish | Chrome / Satin Nickel / Matte Black

Art. No. LHL-004

Lever Lockset (Glass to Wall)

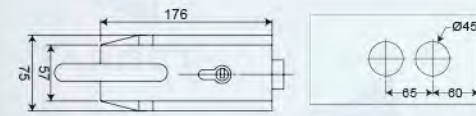
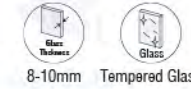

Material | Zinc Alloy
Finish | Chrome / Satin Nickel / Matte Black

Art. No. LHL-592A

Lever Lockset (Glass to Wall)



Material | SUS304
Finish | Polished / Satin / Matte Black

Hinges for Lever Lockset

Art. No. SH-S54

Free Swing Door Hinge

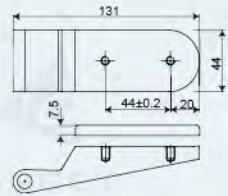
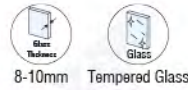

Material Aluminium
Finish Satin / Silver / Matte Black

Art. No. SH-S55

Free Swing Door Hinge

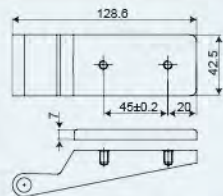
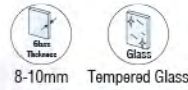

Material Aluminium
Finish Satin / Silver / Matte Black

Art. No. SH-S118

Free Swing Door Hinge

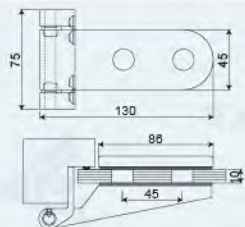

Material Aluminum
Finish Satin / Silver / Matte Black

SH-S119

Free Swing Door Hinge

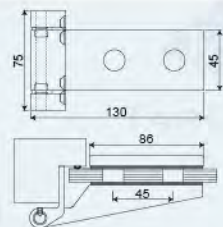

Material Aluminum
Finish Satin / Silver / Matte Black

Hinges for Lever Lockset

Art. No. SH-S56

Free Swing Door Hinge

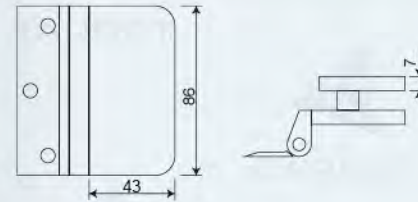
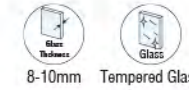

Material Aluminium
Finish Satin / Silver / Matte Black

Art. No. SH-S59

Free Swing Door Hinge

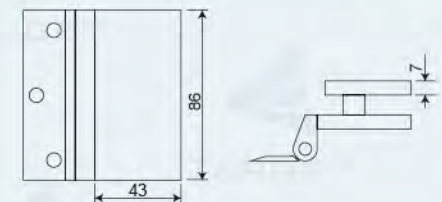

Material Aluminium
Finish Satin / Silver / Matte Black

Art. No. SH-S58

Free Swing Door Hinge

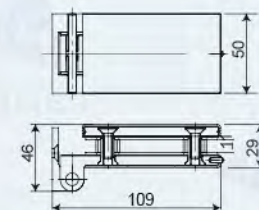
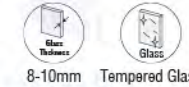

Material SUS304 / Aluminum
Finish Silver / Satin / Matte Black

Art. No. SH-S77

Free Swing Door Hinge

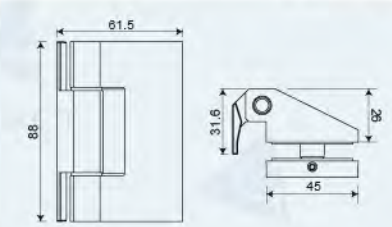

Material Aluminum
Finish Satin / Silver / Matte Black

Glass Locks



Art. No. LHL-201
Glass to Wall (No Glass Cutout)

Material
Zinc Alloy
Finish
Chrome / Satin Nickel

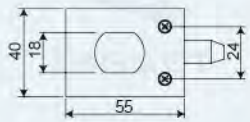

Art. No. LHL-204
Glass to Wall

Material
Zinc Alloy
Finish
Chrome / Satin Nickel

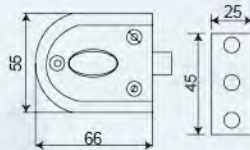

Art. No. LHL-604
Glass to Glass (No Glass Cutout)

Material
Brass
Finish
Chrome / Satin Nickel

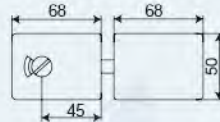

Art. No. LHL-202
Glass to Glass (No Glass Cutout)

Material
Zinc Alloy
Finish
Chrome / Satin Nickel

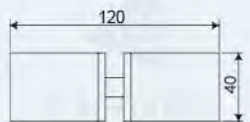

Art. No. LHL-205
Glass to Glass

Material
Zinc Alloy
Finish
Chrome / Satin Nickel

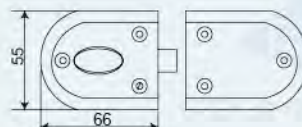

Art. No. LHL-602
Glass to Glass

Material
Zinc Alloy
Finish
Chrome / Satin Nickel

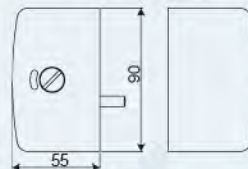

Glass Locks



Art. No. LHL-029
Glass to Glass (No Glass Cutout)

Material
SUS201 / SUS304
Finish
Polished / Satin

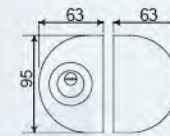

Art. No. LHL-049
Glass to Wall (No Glass Cutout)

Material
SUS201 / SUS304
Finish
Polished / Satin

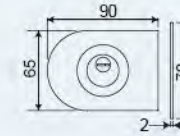

Art. No. LHL-037
Glass to Wall (No Glass Cutout)

Material
SUS201 / SUS304
Finish
Polished / Satin

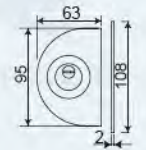

Art. No. LHL-606
Glass to Glass (No Glass Cutout)

Material
SUS304
Finish
Polished / Satin

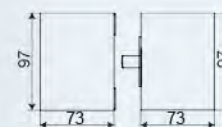

Art. No. LHL-048
Glass to Glass (No Glass Cutout)

Material
SUS201 / SUS304
Finish
Polished / Satin

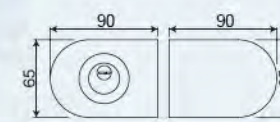

Art. No. LHL-038
Glass to Glass (No Glass Cutout)

Material
SUS201 / SUS304
Finish
Polished / Satin

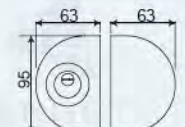

MINI Posts
No Glass Cutout



Art. No. SP-058
MINI Posts

Designed for Use	No glass cutout Adjustable base Indoor and outdoor
Varieties	Top mount
Application	Balustrades
Material	SUS304 / SUS316 / 2205
Infills	Glass
Glass thickness	10-12mm
Finish	Polished / Satin / Matte Black

Adjustable Distance

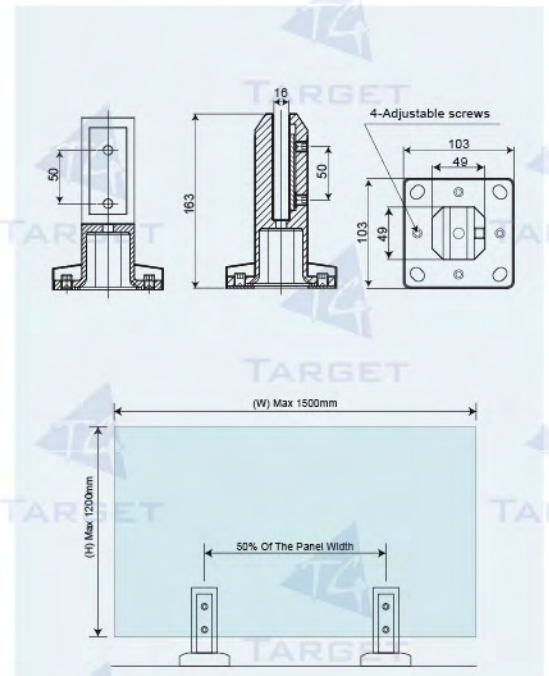
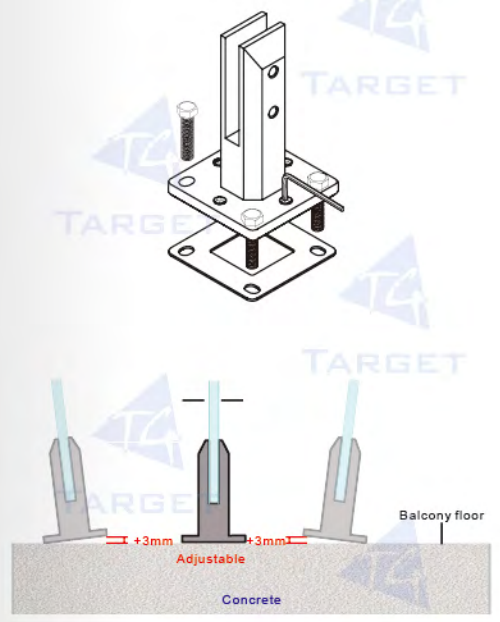

Place the spigot on to top of 2mm plate, lift the cover plate and tighten the mounting screw. With the grub screw adjust the spigot.

MINI Posts

No Glass Cutout

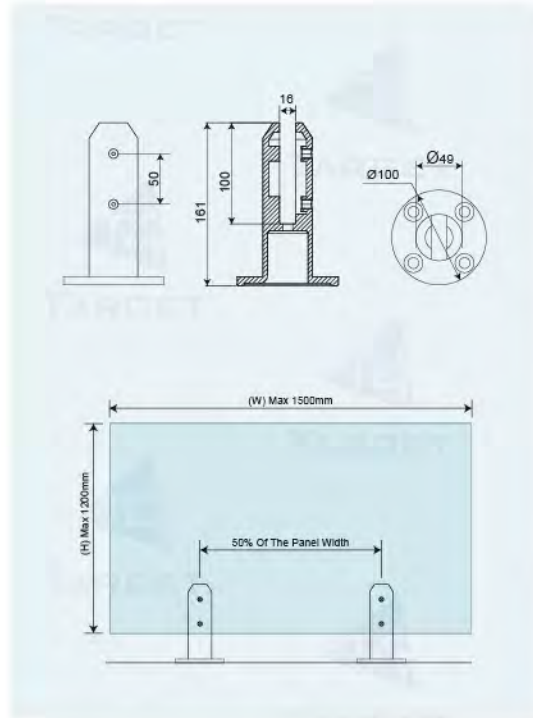

Art. No. SP-013

MINI Posts

Material SUS304 / SUS316 / 2205
Finish Polished / Satin / Matte Black
Glass Thickness 10-12mm

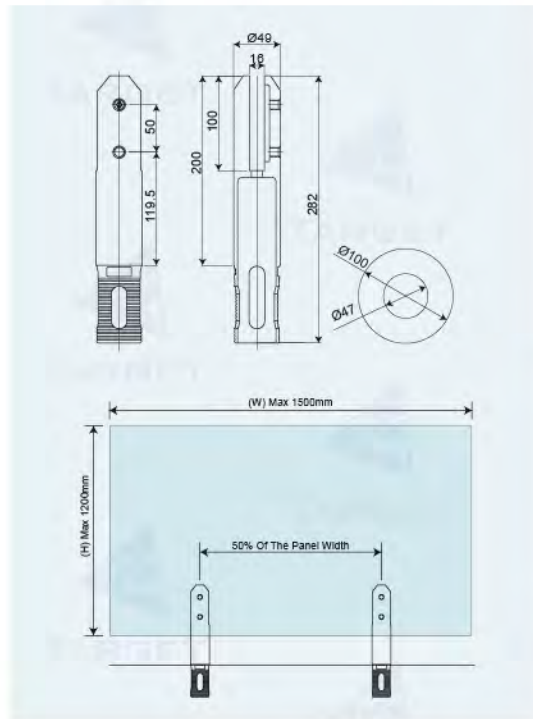

Art. No. SP-014

MINI Posts

Material SUS304 / SUS316 / 2205
Finish Polished / Satin / Matte Black
Glass Thickness 10-12mm

MINI Posts

No Glass Cutout

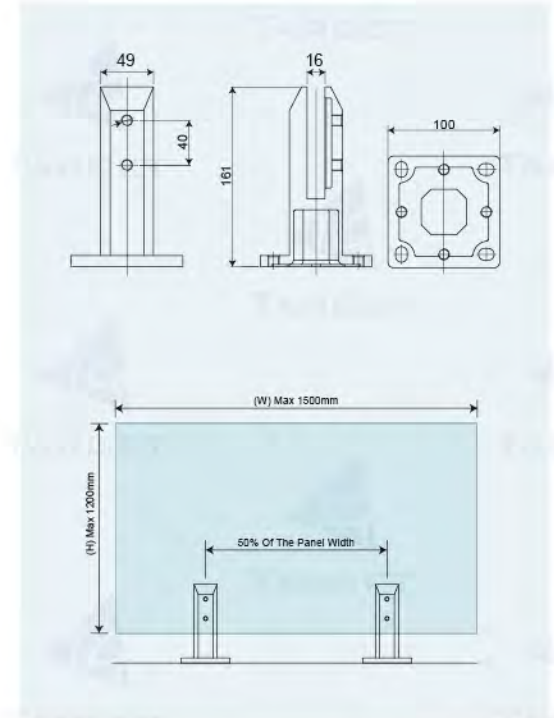

Art. No. SP-011

MINI Posts

Material SUS304 / SUS316 / 2205
Finish Polished / Satin / Matte Black
Glass Thickness 10-12mm

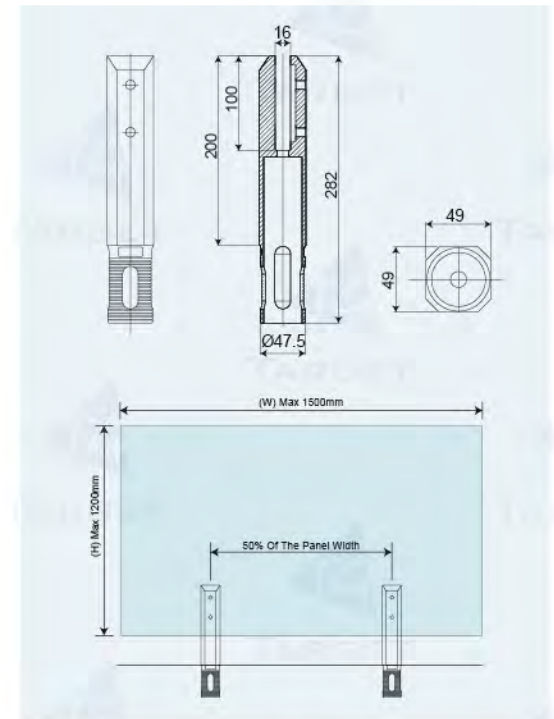

Art. No. SP-012

MINI Posts

Material SUS304 / SUS316 / 2205
Finish Polished / Satin / Matte Black
Glass Thickness 10-12mm

MINI Posts



Art. No. SP-004

MINI Posts

Material | SUS304 / SUS316 / 2205
Finish | Polished / Satin / Matte Black
Glass Thickness | 10-12mm

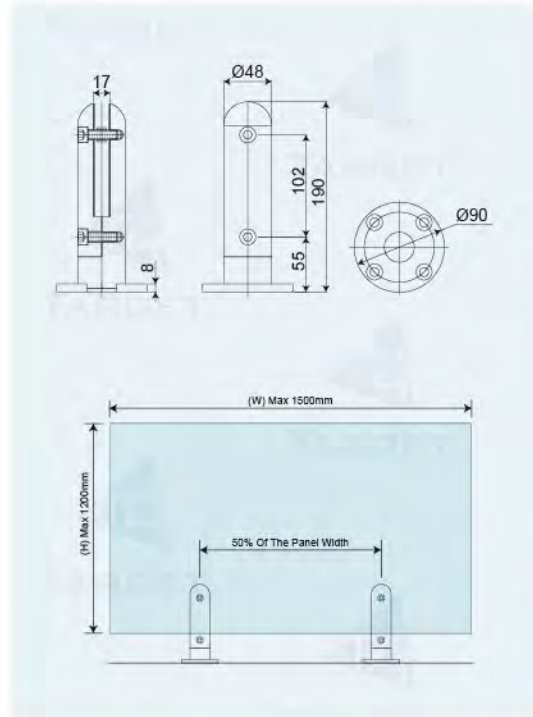

Art. No. SP-001

MINI Posts

Material | SUS304 / SUS316 / 2205
Finish | Polished / Satin / Matte Black
Glass Thickness | 10-12mm

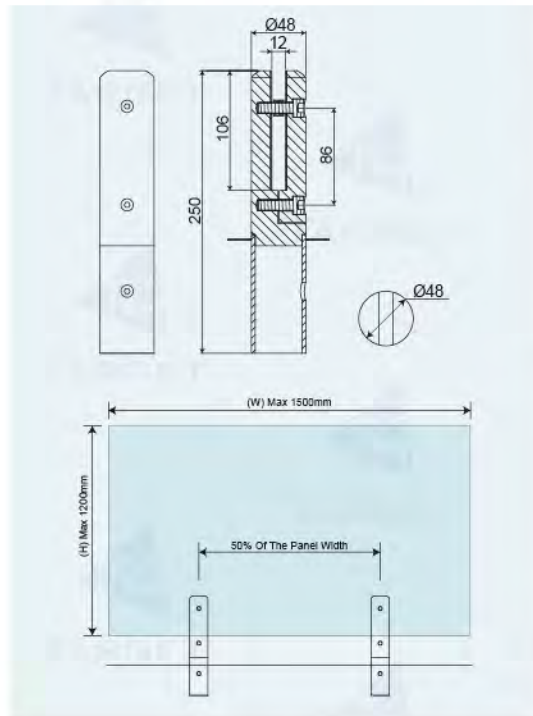

Glass Clamp

Art. No. SF-M006A

Connector (Glass to Glass, 90°)

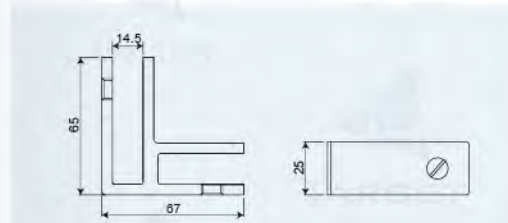
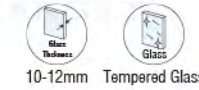

Material | SUS304 / SUS316 / 2205
Finish | Polished / Satin / Matte Black

Art. No. SF-M007A

Connector (Glass to Glass, Adjustable)

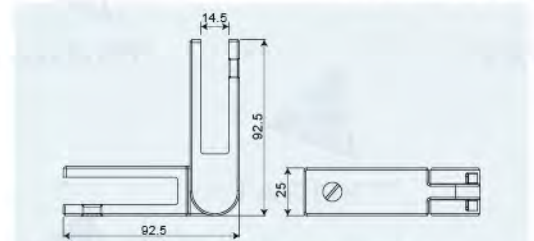

Material | SUS304 / SUS316 / 2205
Finish | Polished / Satin / Matte Black

Art. No. SF-M008A

Connector (Glass to Glass)

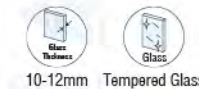

Material | SUS304 / SUS316 / 2205
Finish | Polished / Satin / Matte Black

Art. No. SF-M009A

Connector (Glass to Wall, 90°)

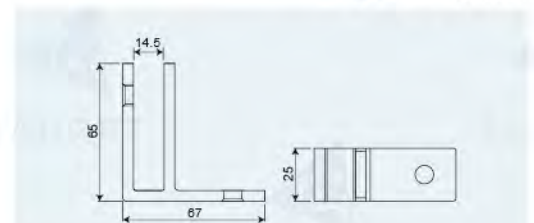

Material | SUS304 / SUS316 / 2205
Finish | Polished / Satin / Matte Black

Latch & Hinge

Art. No. SP-M101C

Latch & Keeper

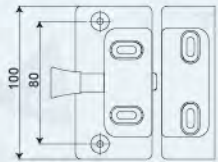

Material SUS304 / SUS316
Finish Polished / Satin

Art. No. SP-M102C

Latch & Keeper

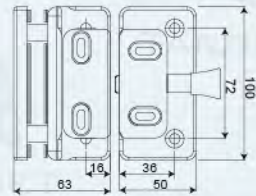

Material SUS304 / SUS316
Finish Polished / Satin

Art. No. SP-M103C

Latch & Keeper

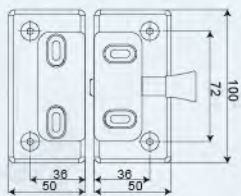

Material SUS304 / SUS316
Finish Polished / Satin

Art. No. SP-M104C

Latch & Keeper

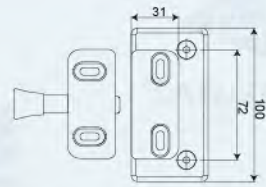

Material SUS304 / SUS316
Finish Polished / Satin

Latch & Hinge

Art. No. SPM-020

Safety Hinge

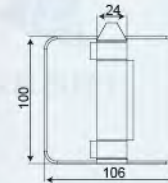

Material SUS304 / SUS316
Finish Polished / Satin

Features

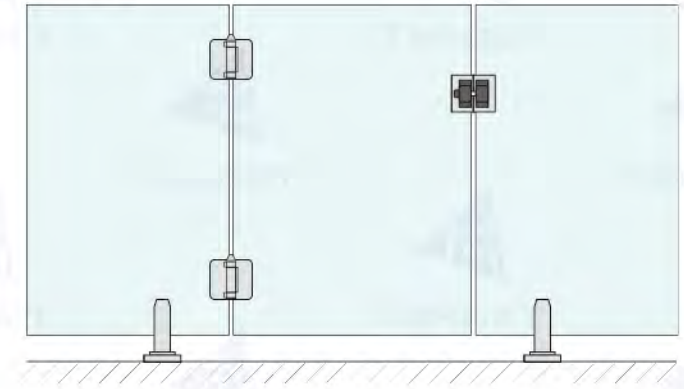

Pull Gate Pivot Accessories

Art. No. SP-201

Pivot arm top-glass to solid wall



Art. No. SP-101

Pivot top-bracket



Features

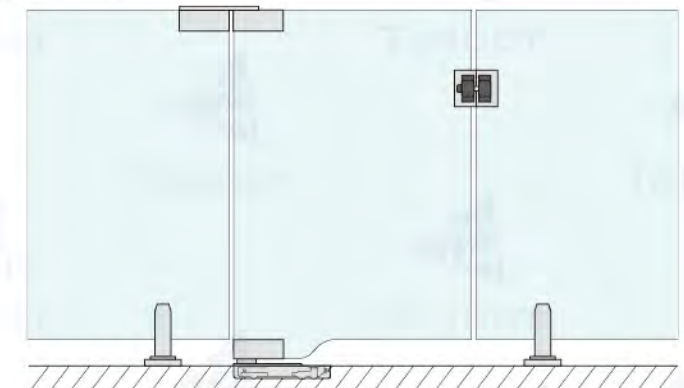

Art. No. SP-301

Pivot arm top-glass to glass



Aluminum Profile



Art. No. SFL-101AL

Glass Mounting U Channel

Material

Aluminum

Finish

Chrome / Satin Nickel / Matte Black / Gold

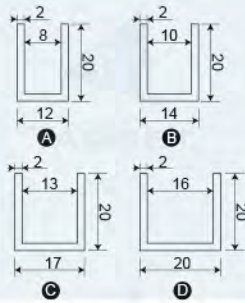

Art. No. SFL-101

Glass Mounting U Channel

Material

SUS304

Finish

Polished / Satin / Matte Black / Gold

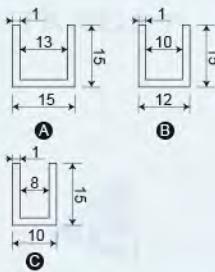

New

Art. No. SL-513

End Cap for Glass Mounting U Channel

Material

SUS304

Finish

Polished / Satin / Matte Black / Gold

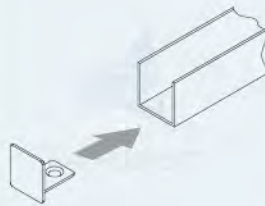

New

Art. No. SFL-136

Bars Profile With Self Adhesive Tape

Material

Aluminum

Finish

Chrome / Satin Nickel / Matte Black Gold

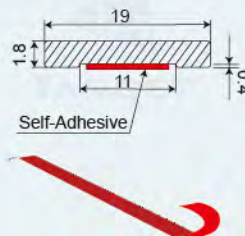

Aluminum Profile



Art. No. SFL-107

Glass Mounting U Channel

Material

Aluminum

Finish

Chrome / Satin Nickel / Matte Black / Gold

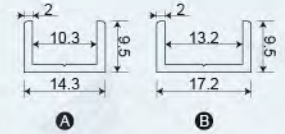

Art. No. SFL-114

Glass Mounting U Channel

Material

Aluminum

Finish

Chrome / Satin Nickel / Matte Black / Gold

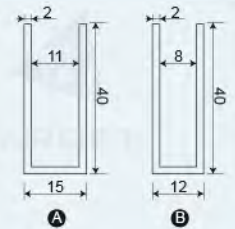

Art. No. SFL-111

Aluminum Angle Extrusion

Material

Aluminum

Finish

Chrome / Satin Nickel / Matte Black / Gold

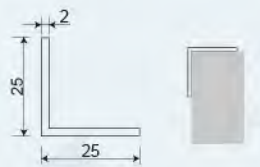

New

Art. No. SL-033

Wall Profile For PVC Seal

Material

Aluminum

Finish

Chrome / Satin Nickel / Matte Black / Gold

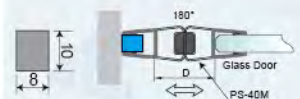

Aluminum Profile



New

Art. No. SFL-120
90° Connection Profile

Material
Aluminum

Finish
Chrome / Satin Nickel / Matte Black / Gold

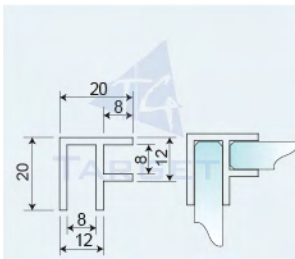

New

Art. No. SL-029
Closure Profile for Magnetic Seal

Material
Aluminum

Finish
Chrome / Satin Nickel / Matte Black / Gold

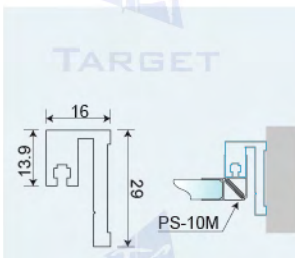

Aluminum profile is for shower door installation securing fixed panels of glass to wall, ceiling or floor. Optional widths to fit different thickness of glass. Aluminum profile comes with film to protect the finish.



Glass Range of Fixing Standoff Series



Glass Standoff

QUICK-LOCK Glass Standoff

New



Art. No. SFC-222

Material
SUS304 / SUS316

Finish
Polished / Satin / Matte Black

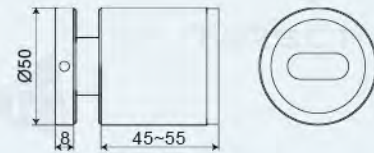

Specifications

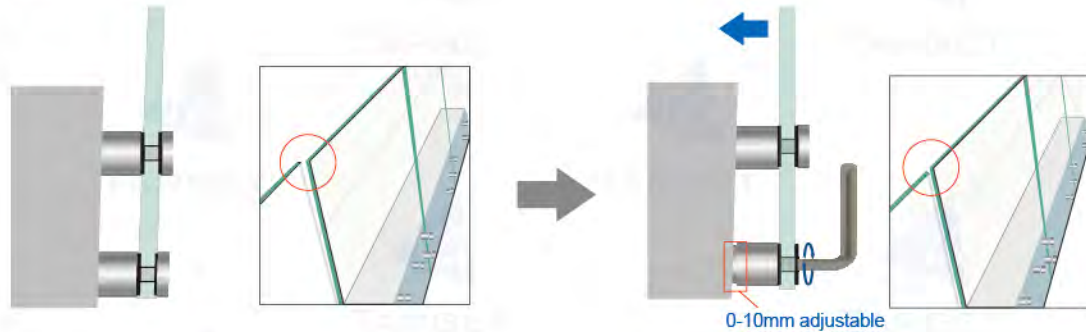

Adjustable glass alignment at any stage during installation.
We have designed to minimise installation time.
This is a Premium choice! Once you try them, you will never use anything else!

Glass Details



Glass Standoff

Art. No. SFC-206

Adjustable Glass Standoff

Material
SUS304 / SUS316

Finish
Polished / Satin / Matte Black

Glass Details

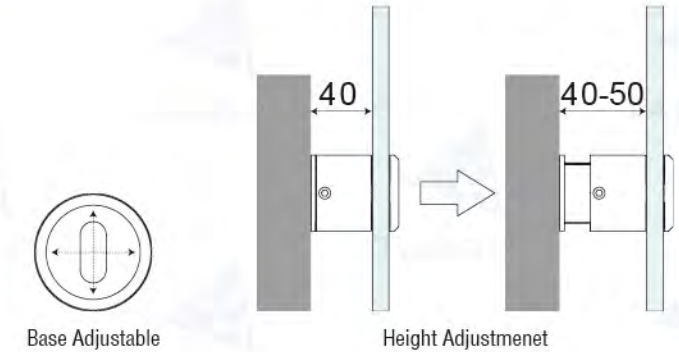
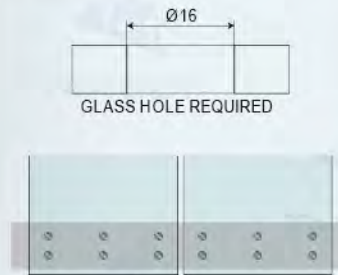

Art. No. SFC-210

Adjustable Glass Standoff

Material
SUS304 / SUS316

Finish
Polished / Satin / Matte Black

Glass Details

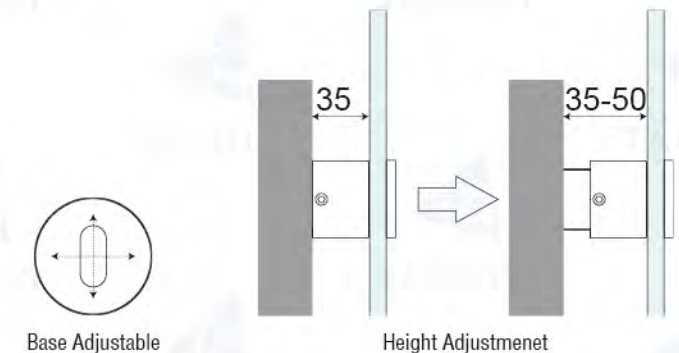
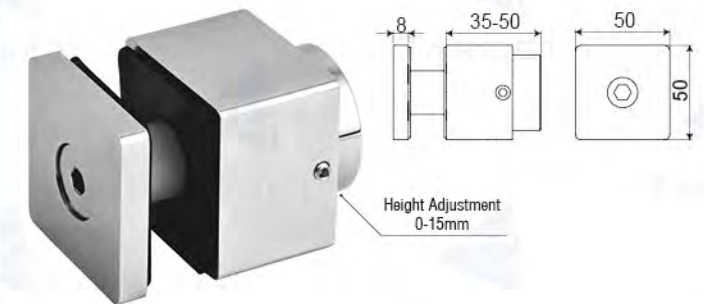
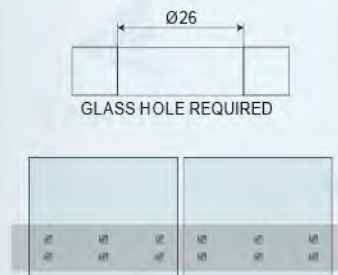

Glass Standoff



Art. No. OF-F-10
Single Point Fixing

Material
SUS304 / SUS316
Finish
Polished / Satin

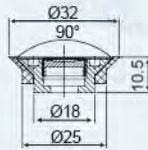

Art. No. OF-F-11
Single Point Fixing

Material
SUS304 / SUS316
Finish
Polished / Satin

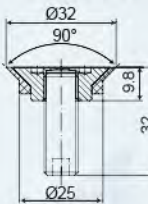

Art. No. OF-F-1
Single Point Fixing
(Not adjustable: 6.5mm)

Material
SUS304 / SUS316
Finish
Polished / Satin

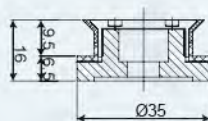

Art. No. OF-F-3
Single Point Fixing
(Adjustable: 12-15mm)

Material
SUS304 / SUS316
Finish
Polished / Satin

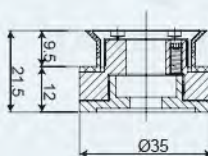

Glass Standoff



Art. No. OF-F-4
Single Point Fixing
(Adjustable: 15-19mm)

Material
SUS304 / SUS316
Finish
Polished / Satin

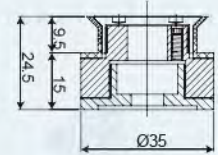

Art. No. OF-F-5
Single Point Fixing
(Adjustable: 19-23mm)

Material
SUS304 / SUS316
Finish
Polished / Satin

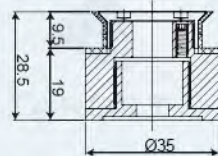

Art. No. OF-F-8
Single Point Fixing
(Adjustable: 23-29mm)

Material
SUS304 / SUS316
Finish
Polished / Satin

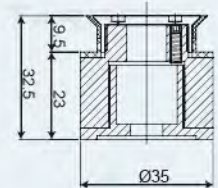

Art. No. OF-F-9
Single Point Fixing
(Not Adjustable: 6.5mm)

Material
SUS304 / SUS316
Finish
Polished / Satin

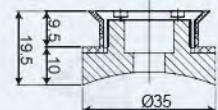

Glass Standoff



Art. No. SFC-201

Glass Standoff

Material
SUS304 / SUS316

Finish
Polished / Satin / Matte Black

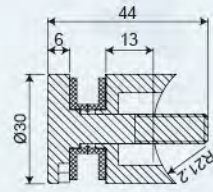

Art. No. SFC-202

Glass Standoff

Material
SUS304 / SUS316

Finish
Polished / Satin / Matte Black

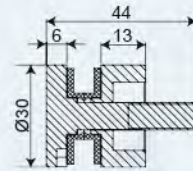

Art. No. SFC-205

Glass Standoff

Material
SUS304 / SUS316

Finish
Polished / Satin / Matte Black

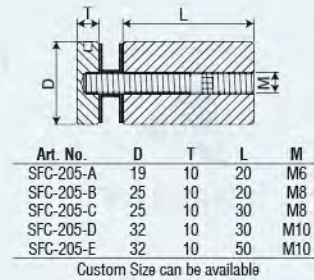

Art. No. SFC-204

Glass Standoff

Material
SUS304 / SUS316

Finish
Polished / Satin / Matte Black

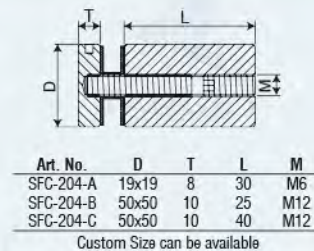

Glass Standoff



Art. No. SFC-214

Glass Standoff

Material
SUS304 / SUS316

Finish
Polished / Satin / Matte Black

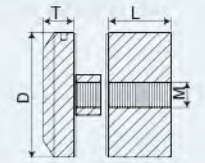

Art. No. SFC-209

Glass Standoff

Material
SUS304 / SUS316

Finish
Polished / Satin / Matte Black

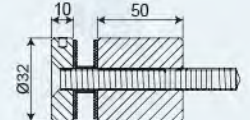

Art. No. SFC-208

Glass Standoff

Material
SUS304 / SUS316

Finish
Polished / Satin / Matte Black

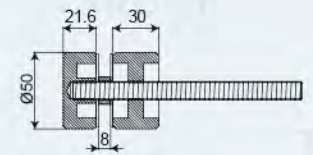

Art. No. SFC-205A

Glass Standoff

Material
SUS304 & Plastic

Finish
Polished / Satin / Matte Black

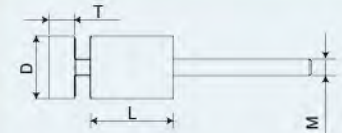

Point Supported Standoff Railing System

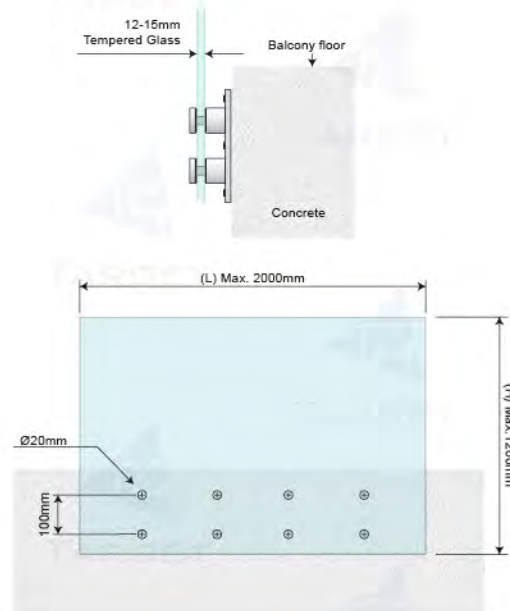

This system is used in several applications such as the perimeter of a terrace or the railing of a balcony. Using the same principle as the fixing spacers for glass, this system allows the installation of glass panels on the facade.

The brackets fixed to the wall plate allow the glass to be moved away from the surface. Excellent corrosion resistance for use in all outdoor installation projects.



New

Art. No. OF-H-25
Round Double-Point Mounting Support System for Glass Railing

- 12-15mm
- 90kg
- 2000x1200mm Tempered Glass
-

Material | SUS304 / SUS316 / 2205
Finish | Polished / Satin / Matte Black

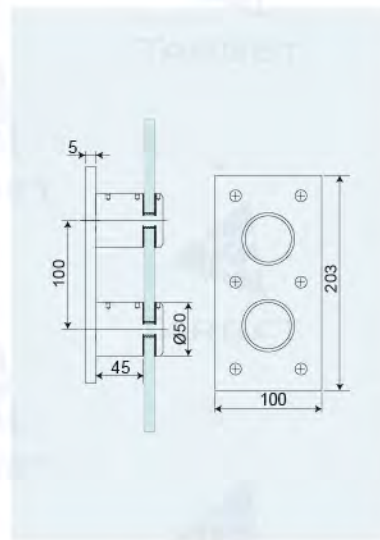

Point Supported Standoff Railing System



New

Art. No. OF-H-21
Round Double-Point Support System for Glass Railing

- 12-15mm
- 90kg
- 2000x1200mm Tempered Glass
-

Material | SUS304 / SUS316 / 2205
Finish | Polished / Satin / Matte Black

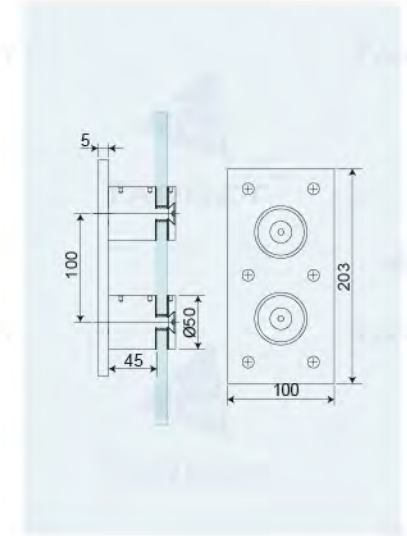

New

Art. No. OF-H-22
Square Double-Point Mounting Bracket for Glass Railing

- 12-15mm
- 90kg
- 2000x1200mm Tempered Glass
-

Material | SUS304 / SUS316 / 2205
Finish | Polished / Satin / Matte Black

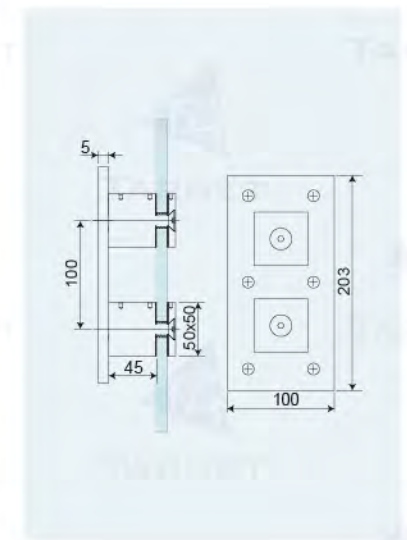

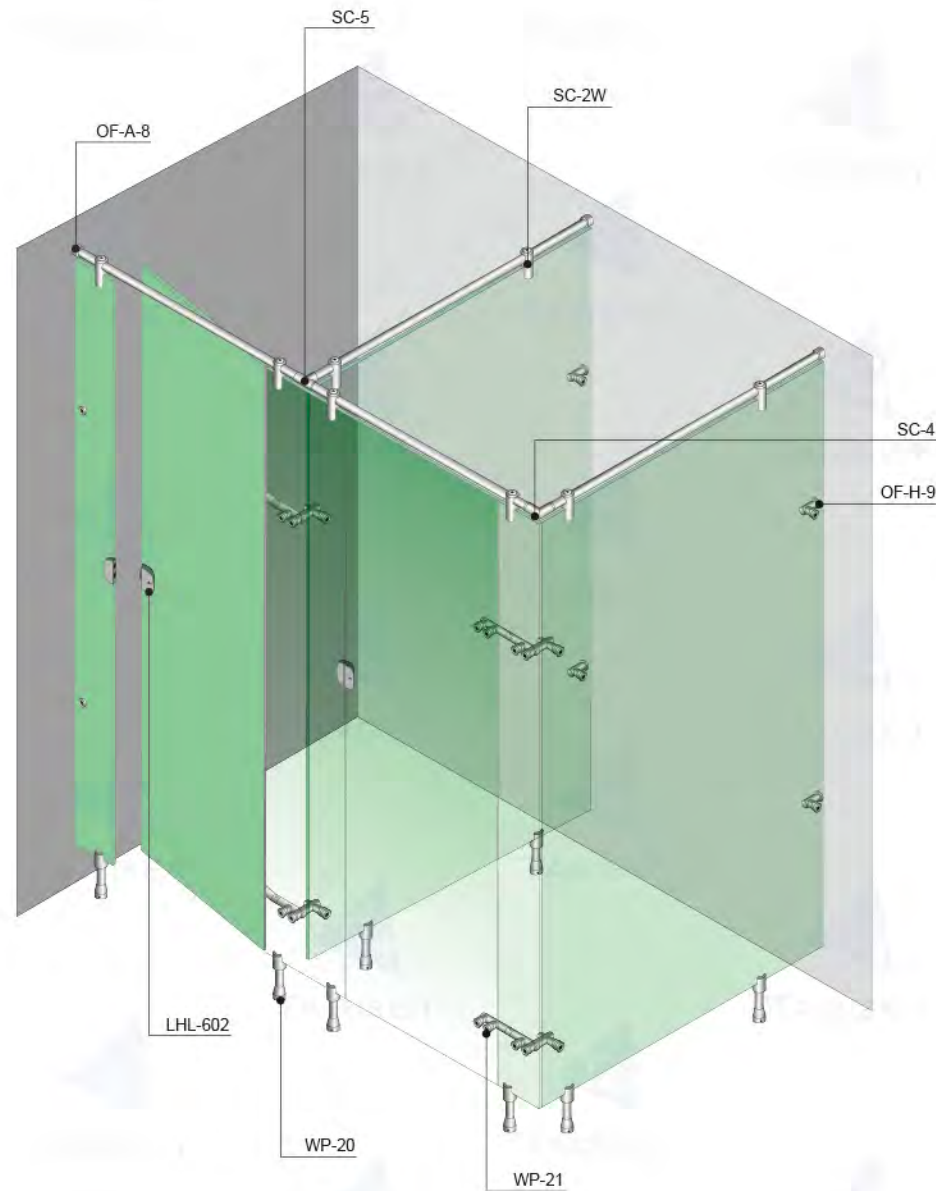

Washroom Fittings & Glass Door Hinges

Besides offering full range of shower room hardware accessories, we are also experienced in industry of architectural hardware fittings for years. Offering varieties of products is our advantage. We believe our products can meet your need for different design of project.

Glass Fitting & Glass Door Hinges

Art. No. WP-20
Panel Support Leg

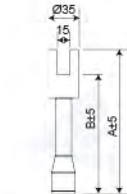

A	125	245
B	105	225

Material	SUS304 / SUS316
Finish	Polished / Satin

Art. No. WP-21
Angle Door Hinge

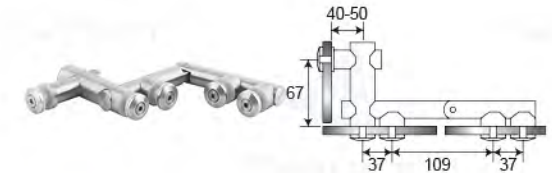

Material	SUS304 / SUS316
Finish	Polished / Satin

Art. No. SC-2W
Bar to Glass Centre Bracket

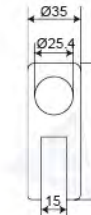

Material	SUS304 / SUS316
Finish	Polished / Satin

Art. No. OF-H-9
Angle Bracket

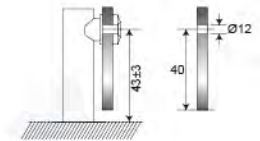

Material	SUS304 / SUS316
Finish	Polished / Satin

Art. No. SC-4
90° Connector

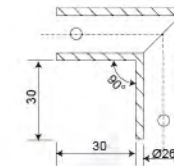

Material	SUS304 / SUS316
Finish	Polished / Satin

Art. No. SC-5
Tee-Coupler

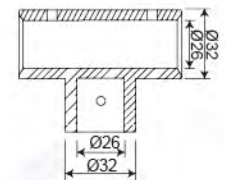

Material	SUS304 / SUS316
Finish	Polished / Satin

Glass Fitting & Glass Door Hinges

Art. No. LHL-602

Lock



Material | Brass
Finish | Chrome / Satin Nickel

Art. No. OF-G-10

Corner Bracket



Material | SUS304 / SUS316
Finish | Polished / Satin

Art. No. OF-G-11

Angle Bracket



Material | SUS304 / SUS316
Finish | Polished / Satin

Art. No. OF-G-12

Angle Bracket



Material | SUS304 / SUS316
Finish | Polished / Satin

Art. No. SF-06D

Angle Bracket

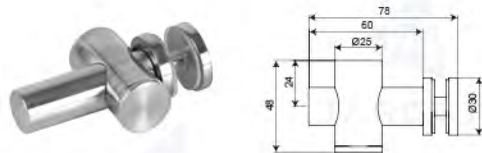

Material | SUS304 / SUS316
Finish | Polished / Satin

Art. No. SF-09D

Door Hinge

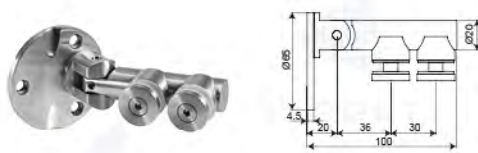

Material | SUS304 / SUS316
Finish | Polished / Satin

Glass Fitting & Glass Door Hinges

Art. No. SF-13D

Door Hinge



Material | SUS304 / SUS316
Finish | Polished / Satin

Art. No. OF-G-2

Mounting Connector



Material | SUS304 / SUS316
Finish | Polished / Satin

Art. No. OF-H-14

Angle Bracket

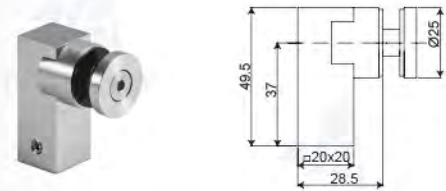

Material | SUS304 / SUS316
Finish | Polished / Satin

Art. No. OF-H-13

Mounting Connector

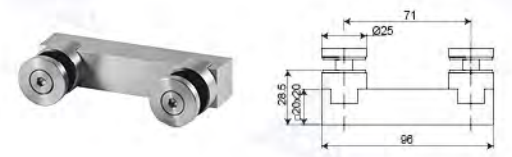

Material | SUS304 / SUS316
Finish | Polished / Satin

Art. No. OF-H-11

Door Hinge

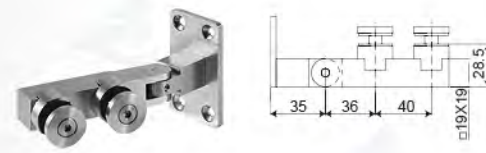

Material | SUS304 / SUS316
Finish | Polished / Satin

Art. No. OF-H-12

Door Hinge

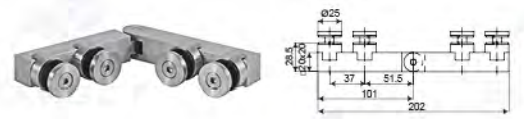

Material | SUS304 / SUS316
Finish | Polished / Satin

Glass UV Hinge

Art. No. FHG-011

UV Hinge

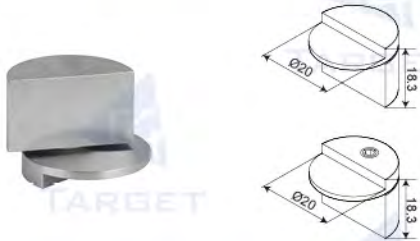

Material SUS304 / SUS316
Finish Polished / Satin

For UV gluing, opening angle 180°. max. load/pair 10 kgs. for doors with a glass thickness of 6 to 10mm. at least 28 mm must be allowed at the side of the cabinet for the door.

Art. No. FHG-001

UV Hinge

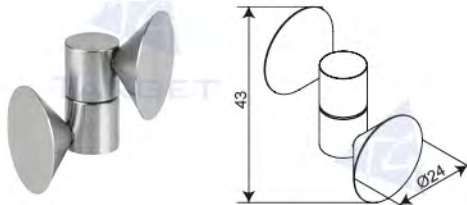

Material SUS304 / SUS316
Finish Polished / Satin

High quality stainless steel hinge suitable for inset doors. for glass thicknesses up to 12 mm and max. door weight of 10 kgs per pair of hinges. a threaded pin in the hinge allows the door to be removed after gluing.

Art. No. FHG-012

UV Hinge

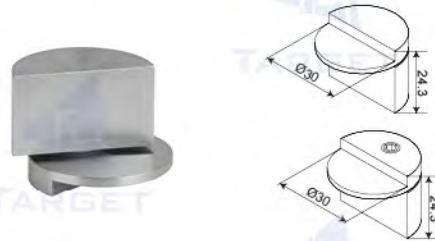

Material SUS304 / SUS316
Finish Polished / Satin

For UV gluing, opening angle 180°. max. load/pair 30 kgs. for doors with a glass thickness of 6 to 15mm. at least 52 mm must be allowed at the side of the cabinet for the door.

Art. No. FHG-002

UV Hinge

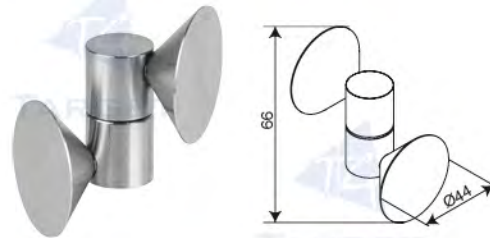

Material SUS304 / SUS316
Finish Polished / Satin

High quality stainless steel hinge suitable for inset doors. for glass thicknesses up to 12mm and max. door weight of 20 kgs per pair of hinges. a threaded pin in the hinge allows the door to be removed after gluing.



HANDRAILS FITTINGS

TARGET is manufacturing wide range of Handrail Kits that are combining the durability of Stainless Steel Components with innovative designs and engineering. These are ensuring the long-term structural integrity and enhance project aesthetics. TARGET has different Handrail Kits that are used in Indoor and Outdoor. Standard Handrail heights are 850mm and 1050mm, but it is also possible to order them in custom heights to meet customer's exact requirements. The Handrails are made of 304 or 316 Stainless Steel that can provide different surface treatments, and are ready for installation. TARGET will be very happy to cooperate with you for any special planning, design and request of Handrail Projects that we have. TARGET is there to provide all the necessary help and support to get the best results and perfect solution.



Glass Railing Aluminum Profile



Glass Railing Aluminum Profile

- Made from high grade Aluminum material
- Available finishes in anodized or powder coated
- Easy-to-do clamp installation
- Compatible with 12mm to 21.52mm monolithic or laminated glass
- Glass and installation tools are sold separately

Glass Railing Aluminum Profile

Art. No. SL-039
Base Profile

New

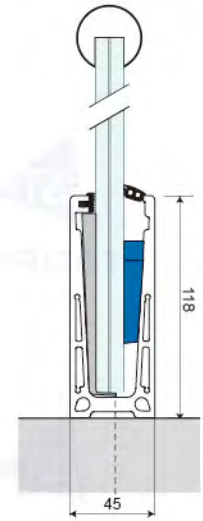
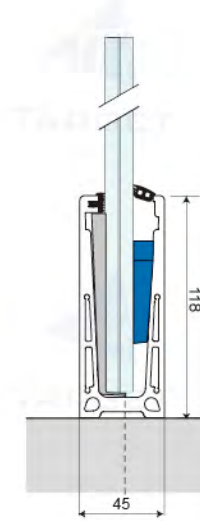

Profile Data

Product Code	Material	Finish	Length(mm)	Glass Thickness
SL-039	Aluminum	Satin / Natural Anodize	5800	12-17.52

System Component



SL-039
Base Profile



SL-039-1A
Plastic Gasket
(for 12,13,14mm)



SL-039-1B
Plastic Gasket
(for 16.76, 7.52mm)



SL-039-2
Spacer



SL-039-3
Glazing Profile



SL-039-4
Glazing Profile



SL-039-5
End Cap

Profile Holes

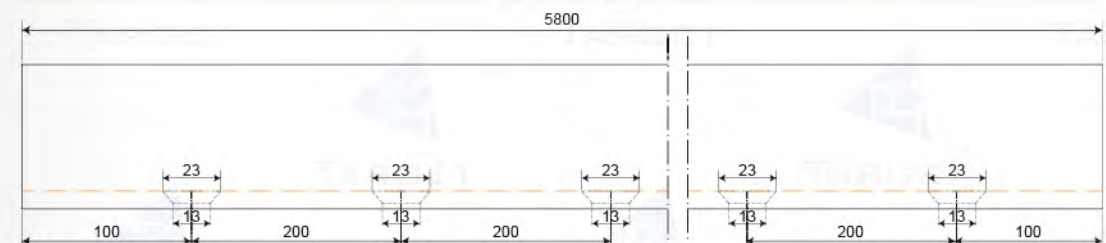

Glass Railing Aluminum Profile

Art. No. SL-040

Base Profile

New

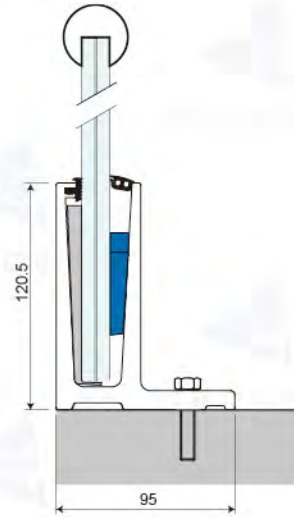

Profile Data

Product Code	Material	Finish	Length(mm)	Glass Thickness
SL-040	Aluminum	Satin / Natural Anodize	5800	12-17.52

System Component



Profile Holes

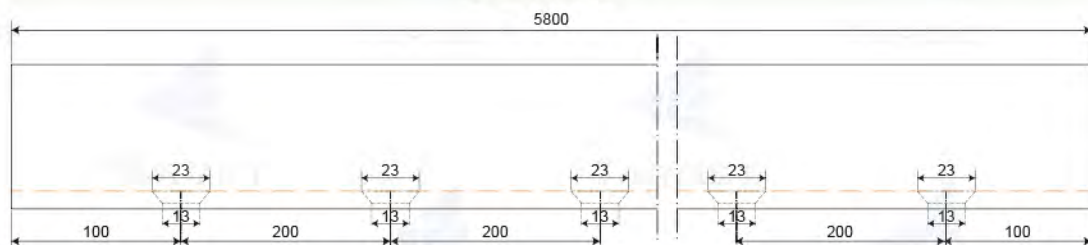

Glass Railing Aluminum Profile

Art. No. SL-041

Base Profile

New

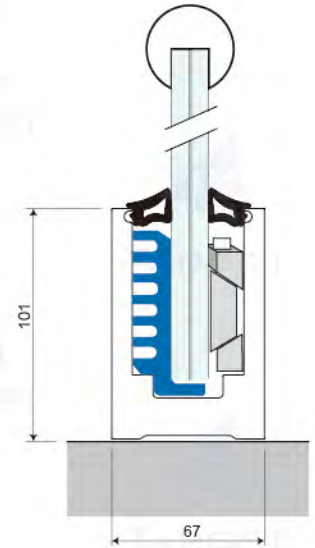

Profile Data

Product Code	Material	Finish	Length(mm)	Glass Thickness
SL-041	Aluminum	Satin / Natural Anodize	5800	12-21.52

System Component



Profile Holes

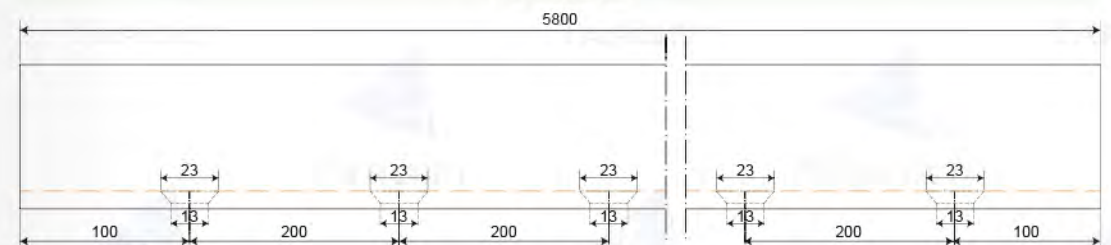



Handrail Series

Art. No. ST-001
Glass Handrail



Art. No. ST-002
Glass Handrail

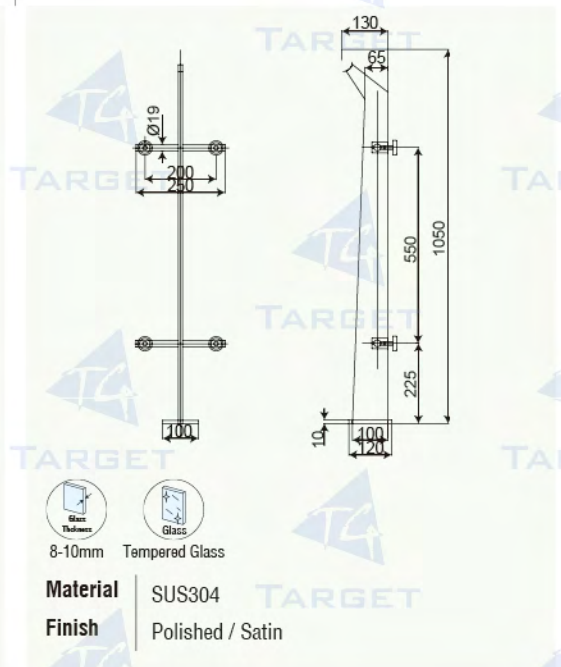
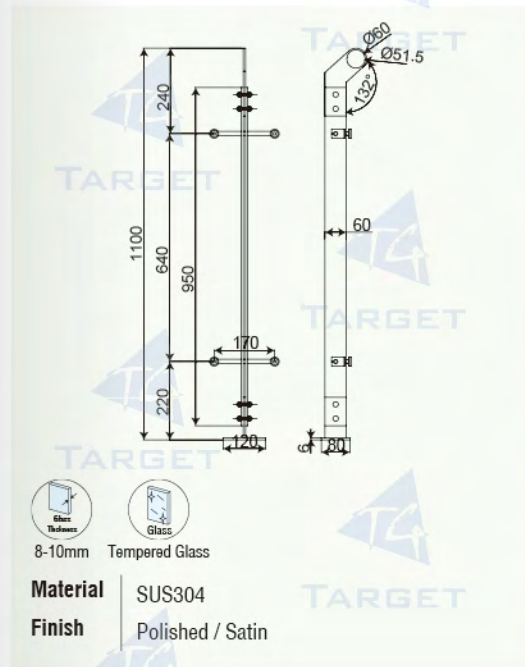

Handrail Series

Art. No. ST-003
Glass Handrail

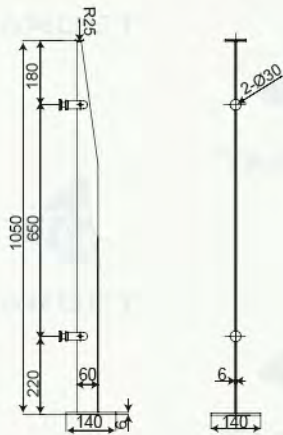

8-10mm Tempered Glass

Material SUS304
Finish Polished / Satin

Art. No. ST-004
Glass Handrail

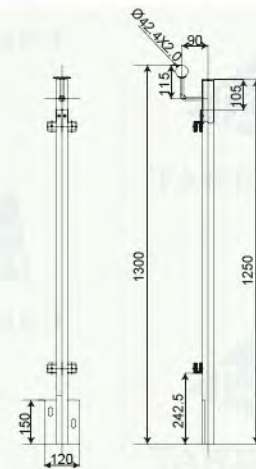

8-10mm Tempered Glass

Material SUS304
Finish Polished / Satin

Handrail Series

Art. No. ST-005
Glass Handrail

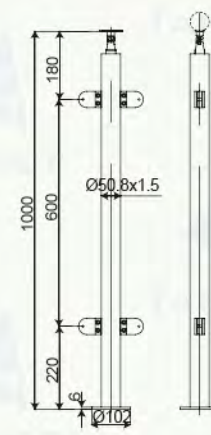

8-10mm Tempered Glass

Material SUS304
Finish Polished / Satin

Art. No. ST-006
Glass Handrail

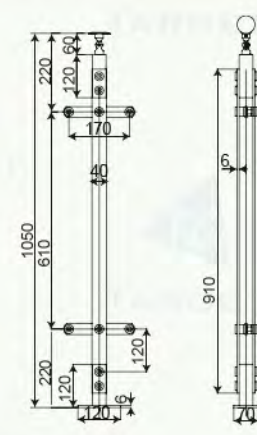

8-10mm Tempered Glass

Material SUS304
Finish Polished / Satin

Handrail Series

Art. No. ST-007
Glass Handrail

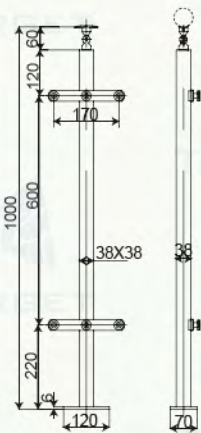

8-10mm Tempered Glass

Material SUS304
Finish Polished / Satin

Art. No. ST-008
Glass Handrail



8-10mm Tempered Glass

Material SUS304
Finish Polished / Satin

Glass Clamps Series



We offer a wide range of Stainless Steel Balustrade styles, all of which are manufactured to the highest standard, using the best quality materials.

From simple handrails to contemporary bespoke balustrades available in a wide range of styles for both the commercial and domestic markets.

Art. No. SFC-104A
Corner Glass Clamp



Material SUS304 / SUS316
Finish Polished / Satin
Glass thickness 8mm + PVB + 8mm glass / 10mm + PVB + 10mm glass

Glass Clamps Series

Art. No. SFC-512FS

Glass Clamps

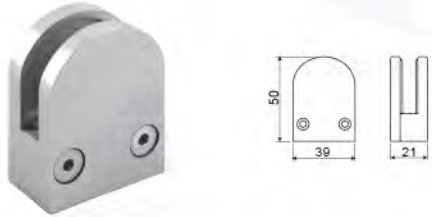

Material SUS304 / SUS316
Finish Polished / Satin
Glass thickness 6-8mm

Art. No. SFC-512RS

Glass Clamps

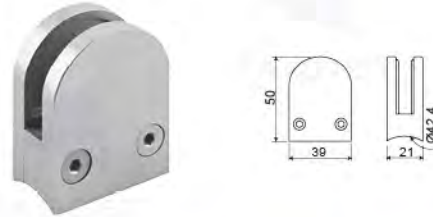

Material SUS304 / SUS316
Finish Polished / Satin
Glass thickness 6-8mm

Art. No. SFC-104B

Glass Clamps

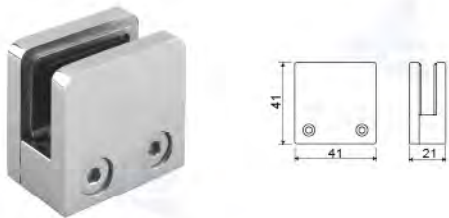

Material SUS304 / SUS316
Finish Polished / Satin
Glass thickness 6-8mm

Art. No. SFC-104RB

Glass Clamps

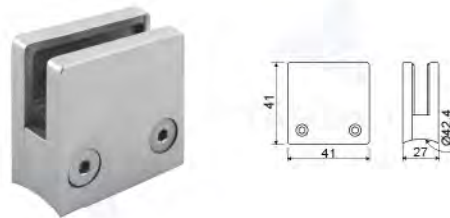

Material SUS304 / SUS316
Finish Polished / Satin
Glass thickness 6-8mm

Art. No. SFC-102

Glass Clamps

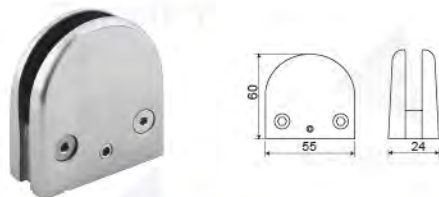

Material SUS304 / SUS316
Finish Polished / Satin
Glass thickness 6-8mm

Art. No. SFC-102R

Glass Clamps

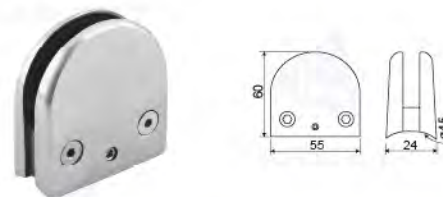

Material SUS304 / SUS316
Finish Polished / Satin
Glass thickness 6-8mm

Glass Clamps Series

Art. No. SFC-513F

Glass Clamps

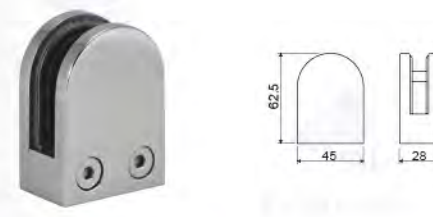

Material SUS304 / SUS316
Finish Polished / Satin
Glass thickness 8-10mm

Art. No. SFC-513R

Glass Clamps

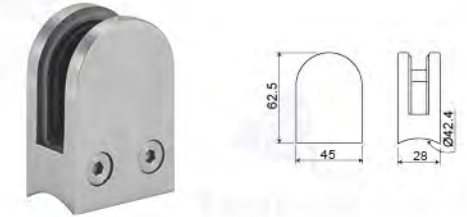

Material SUS304 / SUS316
Finish Polished / Satin
Glass thickness 8-10mm

Art. No. SFC-106F

Glass Clamps

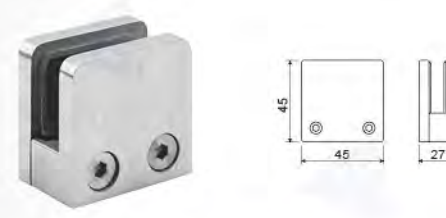

Material SUS304 / SUS316
Finish Polished / Satin
Glass thickness 8-12mm

Art. No. SFC-106R

Glass Clamps

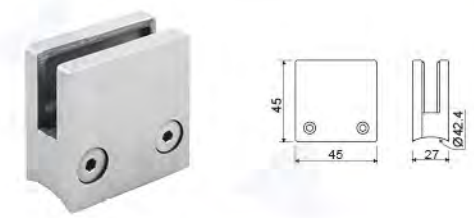

Material SUS304 / SUS316
Finish Polished / Satin
Glass thickness 8-12mm

Art. No. SFC-104F

Glass Clamps



Material SUS304 / SUS316
Finish Polished / Satin
Glass thickness 8-13.5mm

Art. No. SFC-104R

Glass Clamps

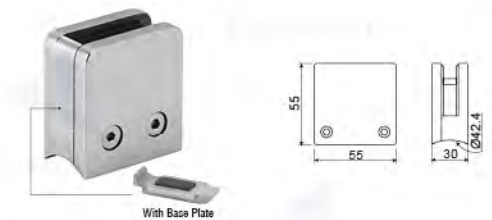

Material SUS304 / SUS316
Finish Polished / Satin
Glass thickness 8-13.5mm

Glass Clamps Series

Art. No. SFC-512F

Glass Clamps

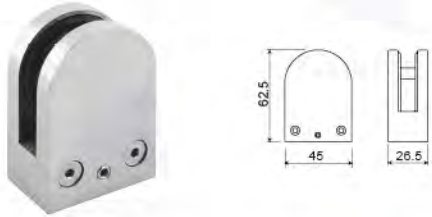

Material SUS304 / SUS316
Finish Polished / Satin
Glass thickness 8-10mm

Art. No. SFC-512R

Glass Clamps

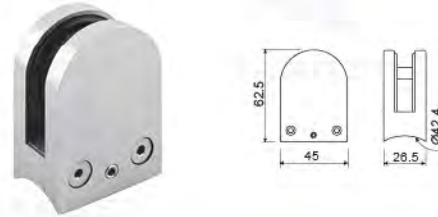

Material SUS304 / SUS316
Finish Polished / Satin
Glass thickness 8-10mm

Art. No. SFC-105F

Glass Clamps

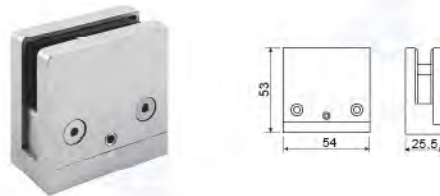

Material SUS304 / SUS316
Finish Polished / Satin
Glass thickness 8-10mm

Art. No. SFC-105R

Glass Clamps

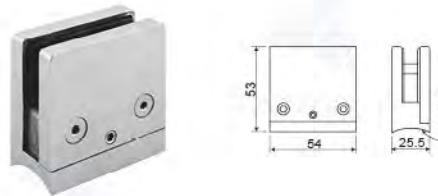

Material SUS304 / SUS316
Finish Polished / Satin
Glass thickness 8-10mm

Art. No. SFC-000R

Glass Clamps

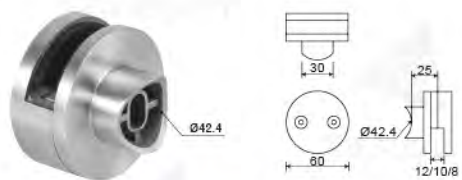

Material SUS304 / SUS316
Finish Polished / Satin
Glass thickness 8-12mm

Art. No. SFC-001R

Glass Clamps

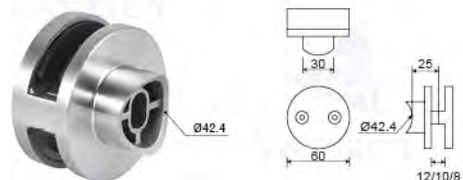

Material SUS304 / SUS316
Finish Polished / Satin
Glass thickness 8-12mm

Glass Clamps Series

Art. No. SFC-002T

Glass Clamps

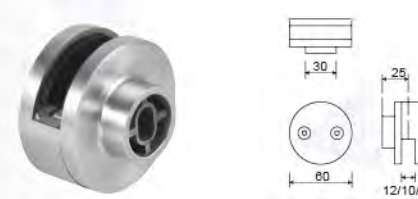

Material SUS304 / SUS316
Finish Polished / Satin
Glass thickness 8-12mm

Art. No. SFC-003T

Glass Clamps

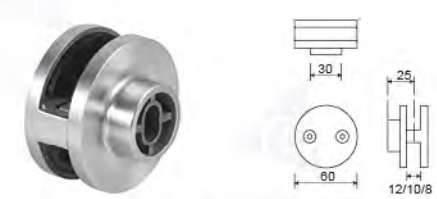

Material SUS304 / SUS316
Finish Polished / Satin
Glass thickness 8-12mm

Art. No. SFC-007F

Glass Clamps

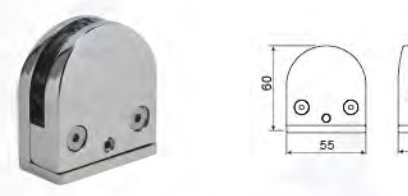

Material Zinc Alloy
Finish Chrome / Satin Nickel
Glass thickness 8-10mm

Art. No. SFC-007R

Glass Clamps

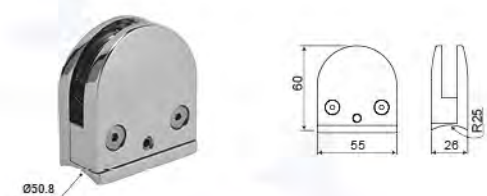

Material Zinc Alloy
Finish Chrome / Satin Nickel
Glass thickness 8-10mm

Art. No. SFC-009F

Glass Clamps

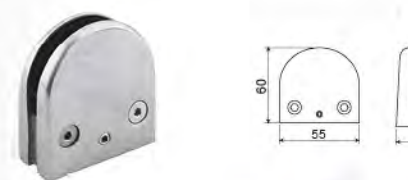

Material Zinc Alloy
Finish Chrome / Satin Nickel
Glass thickness 8-10mm

Art. No. SFC-009R

Glass Clamps

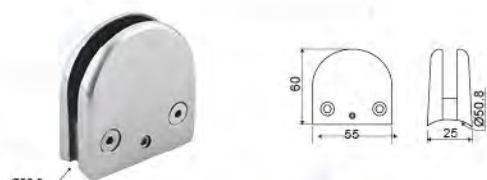

Material Zinc Alloy
Finish Chrome / Satin Nickel
Glass thickness 8-10mm

Handrail Bracket Series



Art. No. SFC-698
Round Handrail



Material | SUS304 / SUS316
Finish | Polished / Satin

Art. No. SFC-700
Rubber Profile

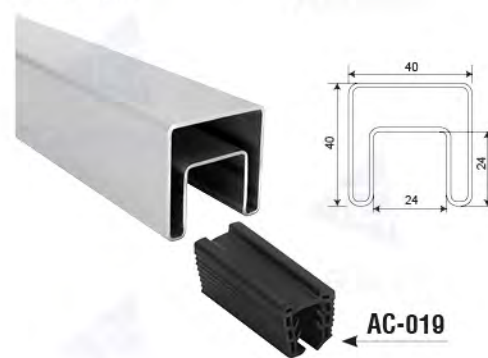

Material | Rubber
Finish | Black

Handrail Bracket Series

Art. No. SFC-639
Baluster flange plate



Material | SUS304 / SUS316
Finish | Polished / Satin

Art. No. SFC-685
Wall flange



Material | SUS304 / SUS316
Finish | Polished / Satin

Art. No. SFC-702
Baluster flange plate



Material | SUS304 / SUS316
Finish | Polished / Satin

Art. No. SFC-703
Straight Connector



Material | SUS304 / SUS316
Finish | Polished / Satin

Art. No. SFC-701
90° Elbow Connector



Material | SUS304 / SUS316
Finish | Polished / Satin

Art. No. SFC-683
Adjustable Connector



Material | SUS304 / SUS316
Finish | Polished / Satin

Handrail Bracket Series

Art. No. SFC-401

Handrail Bracket

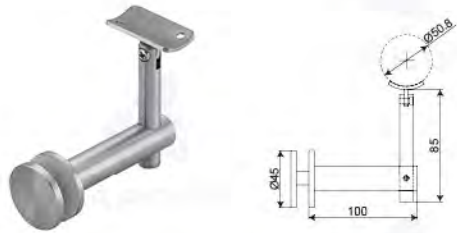

Material | SUS304 / SUS316
Finish | Polished / Satin

Art. No. SFC-402

Handrail Bracket



Material | SUS304 / SUS316
Finish | Polished / Satin

Art. No. SFC-644R

Handrail Bracket



Material | SUS304 / SUS316
Finish | Polished / Satin

Art. No. SFC-643R

Handrail Bracket



Material | SUS304 / SUS316
Finish | Polished / Satin

Art. No. SFC-610

Handrail Bracket



Material | SUS304 / SUS316
Finish | Polished / Satin

Art. No. SFC-611

Handrail Bracket



Material | SUS304 / SUS316
Finish | Polished / Satin

Handrail Bracket Series

Art. No. SFC-406

Handrail Bracket



Material | SUS304 / SUS316
Finish | Polished / Satin

Art. No. SFC-1022

Handrail Bracket



Material | SUS304 / SUS316
Finish | Polished / Satin

Art. No. SFC-407

Adjustable Saddle



Material | SUS304 / SUS316
Finish | Polished / Satin

Art. No. SFC-409

Straight Saddle

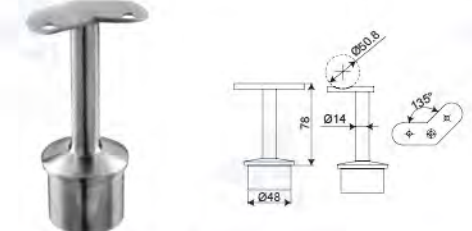

Material | SUS304 / SUS316
Finish | Polished / Satin

Art. No. SFC-410

Straight Saddle

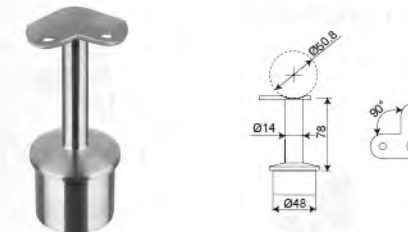

Material | SUS304 / SUS316
Finish | Polished / Satin

Art. No. SFC-408

Straight Saddle



Material | SUS304 / SUS316
Finish | Polished / Satin

Handrail Bracket Series

Art. No. SFC-663

Baluster flange Plate



Material | SUS304 / SUS316
Finish | Polished / Satin

Art. No. SFC-670

90° Elbow Connector



Material | SUS304 / SUS316
Finish | Polished / Satin

Art. No. SFC-669

90° Elbow Connector

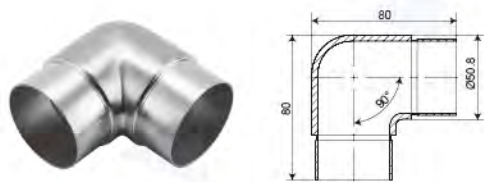

Material | SUS304 / SUS316
Finish | Polished / Satin

Art. No. SFC-508

Tube Connector



Material | SUS304 / SUS316
Finish | Polished / Satin

Art. No. SFC-666

Tube Connector



Material | SUS304 / SUS316
Finish | Polished / Satin

Art. No. SFC-664

Tube Connector



Material | SUS304 / SUS316
Finish | Polished / Satin

Handrail Bracket Series

Art. No. SFC-672

Tube Connector



Material | SUS304 / SUS316
Finish | Polished / Satin

Art. No. SFC-671

Tube Connector

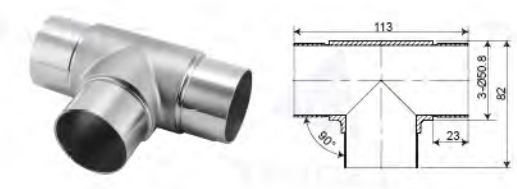

Material | SUS304 / SUS316
Finish | Polished / Satin

Art. No. SFC-673

Tube Connector



Material | SUS304 / SUS316
Finish | Polished / Satin

Art. No. SFC-312

Wall Flange



Material | SUS304 / SUS316
Finish | Polished / Satin

Art. No. SFC-616

Baluster Flange Plate



Material | SUS304 / SUS316
Finish | Polished / Satin

Art. No. SFC-617

Cover Cap

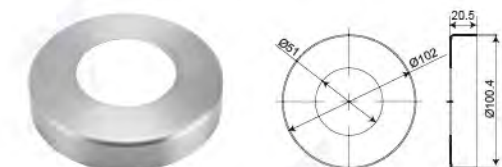

Material | SUS304 / SUS316
Finish | Polished / Satin

Handrail Bracket Series

Art. No. SFC-684

Bar Holder Flat Base



Material | SUS304 / SUS316
Finish | Polished / Satin

Art. No. SFC-687

Bar Holder Radius Base

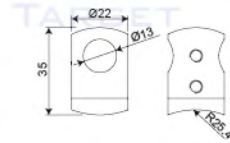

Material | SUS304 / SUS316
Finish | Polished / Satin

Art. No. SFC-682

Bar Holder Flat Base

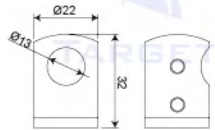

Material | SUS304 / SUS316
Finish | Polished / Satin

Art. No. SFC-707

Bar Holder Radius Base

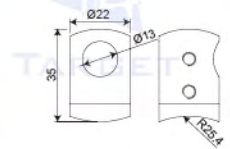

Material | SUS304 / SUS316
Finish | Polished / Satin

Art. No. SFC-615

End Cap

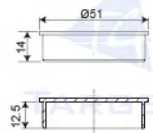

Material | SUS304 / SUS316
Finish | Polished / Satin

Art. No. SFC-318

End Cap



Material | SUS304 / SUS316
Finish | Polished / Satin

Glass Door Hardware



Hydraulic Floor Hinge

Art. No. APF-Y502

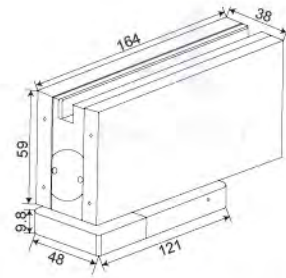

Valve Adjustment

Closing range 1: 105°- 20°
 Closing range 2: 20°- 0°
 Hold-open: 90°
 Open angle: 180° (maximum)

	APF-Y502
Door Weight	≤60kg
Door Width	≤850mm
Material	Aluminium+SUS304
Finish	Polished / Satin
Door Thickness	10-12mm

Glass door cutout dimension



Art. No. APF-Y501

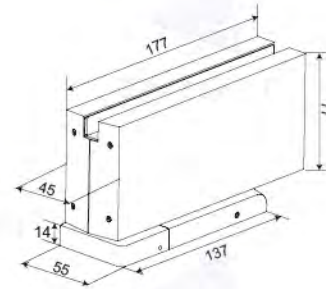

Valve Adjustment

Adjustment of Closing Speed

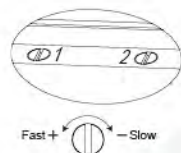
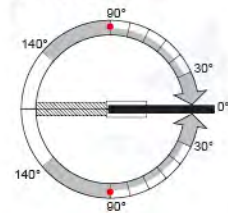

Closing range: 30°- 0° (adjusted by valve 2)
 Closing range: 90°- 30° (adjusted by valve 1)
 Hold-open: 90°
 Open angle: 140° (maximum)

1/4 cycles is recommended for the range of adjustment each time.

Closing Speed



Glass door cutout dimension

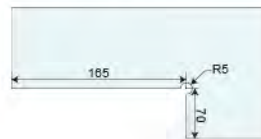

	APF-Y501-100	APF-Y501-150
Door Weight	≤100kg	≤150kg
Door Width	≤1000mm	≤1300mm
Material	Aluminium+SUS304	
Finish	Polished / Satin	
Door Thickness	10-15mm	

Patch Fitting (D Series)



Art. No. APF-005

Bottom Patch Fitting

Material

Aluminium & SUS304

Finish

Polished / Satin



Art. No. APF-006

Top Patch Fitting

Material

Aluminium & SUS304

Finish

Polished / Satin



Art. No. APF-008

Pivot Patch Fitting

Material

Aluminium & SUS304

Finish

Polished / Satin

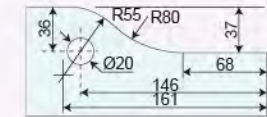
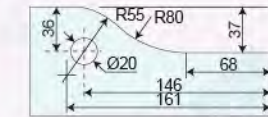
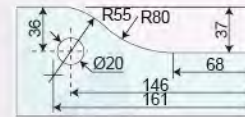

Art. No. APF-024

Pivot Patch Fitting Glass-Wall

Material

Aluminium & SUS304

Finish

Polished / Satin



Art. No. APF-009C

Floor Lock Patch Fitting

Material

Aluminium & SUS304

Finish

Polished / Satin



Art. No. APF-007

Pivot Patch Fitting

Material

Aluminium & SUS304

Finish

Polished / Satin

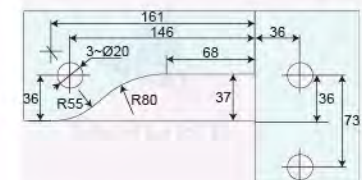
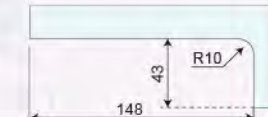
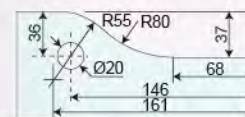

Patch Fitting (D Series)



Art. No. APF-009E
Floor Lock Patch Fitting

Material
Aluminium & SUS304

Finish
Polished / Satin

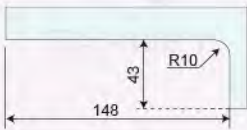

Art. No. APF-015C
Central Lock Patch Fitting

Material
Aluminium & SUS304

Finish
Polished / Satin

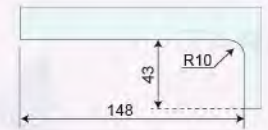

Art. No. APF-015B
Strike Box Patch Fitting

Material
Aluminium & SUS304

Finish
Polished / Satin

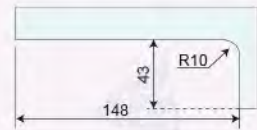

Art. No. APF-014
Pivot Patch Fitting glass-wall

Material
Aluminium & SUS304

Finish
Polished / Satin

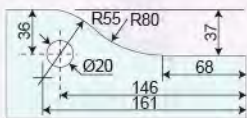

Art. No. APF-027
Strike Box L Patch Fitting

Material
Aluminium & SUS304

Finish
Polished / Satin

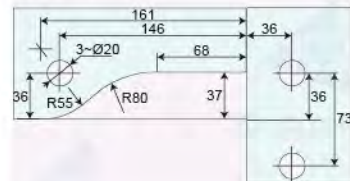

Art. No. APF-035C
Floor Lock Patch Fitting

Material
Aluminium & SUS304

Finish
Polished / Satin

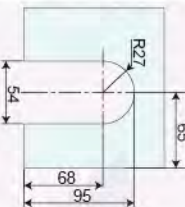

Patch Fitting (D Series)



Art. No. APF-034
L Patch Fitting

Material
Aluminium & SUS304

Finish
Polished / Satin

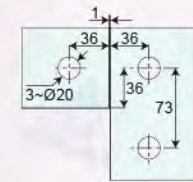

Art. No. APF-064
Stopper Patch Fitting

Material
Aluminium & SUS304

Finish
Polished / Satin

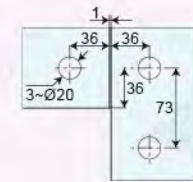

Art. No. APF-074
Sidepanel Patch Fitting

Material
Aluminium & SUS304

Finish
Polished / Satin

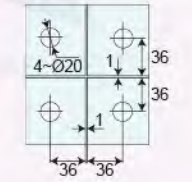

Art. No. APF-084L
L Patch Fitting, Left

Material
Aluminium & SUS304

Finish
Polished / Satin

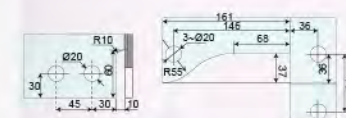

Art. No. APF-084R
L Patch Fitting, Right

Material
Aluminium & SUS304

Finish
Polished / Satin

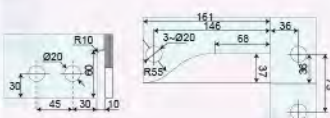

Art. No. APF-049
T Patch Fitting

Material
Aluminium & SUS304

Finish
Polished / Satin

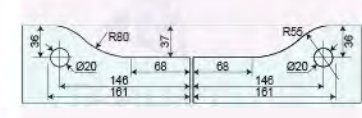

Patch Fitting (C Series)



Art. No. APF-C51000
Bottom Patch Fitting

Material
Aluminium & SUS304
Finish
Polished / Satin

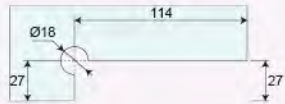

Art. No. APF-C52000
Top Patch Fitting

Material
Aluminium & SUS304
Finish
Polished / Satin

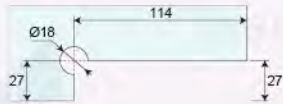

Art. No. APF-C53000
Pivot Patch Fitting Glass-Wall

Material
Aluminium & SUS304
Finish
Polished / Satin

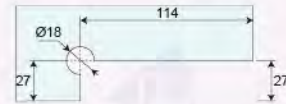

Art. No. APF-C54000
Pivot Patch Fitting

Material
Aluminium & SUS304
Finish
Polished / Satin

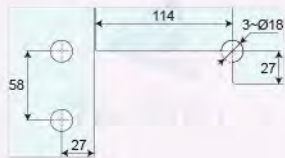

Art. No. APF-C58500
Floor Lock Patch Fitting

Material
Aluminium & SUS304
Finish
Polished / Satin

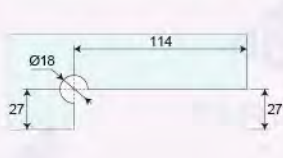

Art. No. APF-C16000
Central Lock Patch Fitting

Material
Aluminium & SUS304
Finish
Polished / Satin

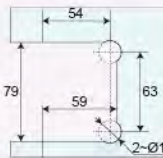

Patch Fitting (M Series)



Art. No. APF-M500
Bottom Patch Fitting

Material
Aluminium & SUS304
Finish
Polished / Satin

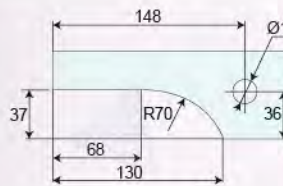

Art. No. APF-M501
Top Patch Fitting

Material
Aluminium & SUS304
Finish
Polished / Satin

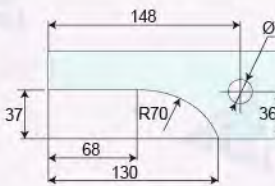

Art. No. APF-M508
Pivot Patch Fitting

Material
Aluminium & SUS304
Finish
Polished / Satin

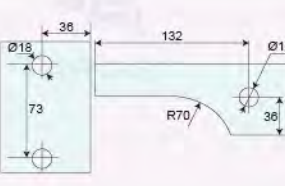

Art. No. APF-M511
Pivot Patch Fitting Glass-Wall

Material
Aluminium & SUS304
Finish
Polished / Satin

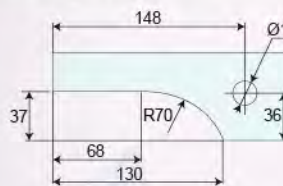

Art. No. APF-025C
Floor Lock Patch Fitting

Material
Aluminium & SUS304
Finish
Polished / Satin

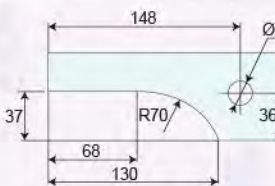

Art. No. APF-037
Strike Box Patch Fitting

Material
Aluminium & SUS304
Finish
Polished / Satin

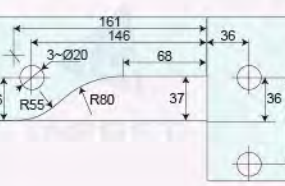

Patch Fitting (M Series)



Art. No. APF-031C

Central Lock Patch Fitting

Material
Aluminium & SUS304

Finish
Polished / Satin

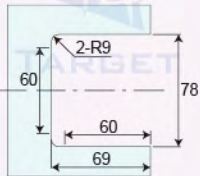

Art. No. APF-031B

Strike Box Patch Fitting

Material
Aluminium & SUS304

Finish
Polished / Satin

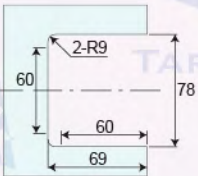

Art. No. APF-021C

Top Lock Patch Fitting

Material
Aluminium & SUS304

Finish
Polished / Satin

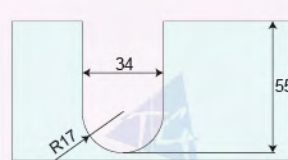

Art. No. APF-021B

Strike Box Patch Fitting

Material
Aluminium & SUS304

Finish
Polished / Satin

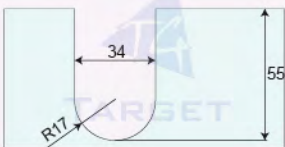

Art. No. APF-022

Glass To Glass Patch Fitting

Material
Aluminium & SUS304

Finish
Polished / Satin

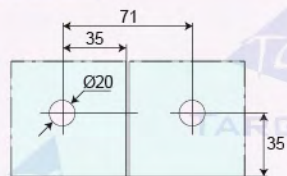

Art. No. APF-012B

Patch Fitting Glass To Wall

Material
Aluminium & SUS304

Finish
Polished / Satin

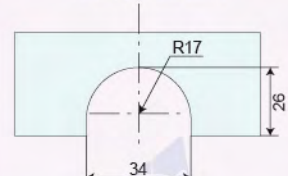

Patch Fitting

Art. No. APF-7000

Side Panel Rails



- New aluminium profile is suitable for 8mm, 10mm and 12mm glass with good convenience and compatibility.
- Excellent solution applicable to different projects
- Peripheral accessories can be removable
- Easy for installation on floor, wall or ceiling
- Length can be customized to fit application

Material Aluminium
Finish Silver / Satin
Length 3000mm
Glass Thickness 8-12mm

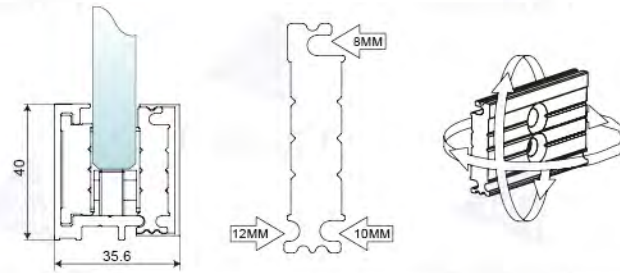

Art. No. APF-6000

Side Panel Rails



Material Aluminium & SUS304
Finish Polished / Satin
Length 3000mm
Glass Thickness 10mm

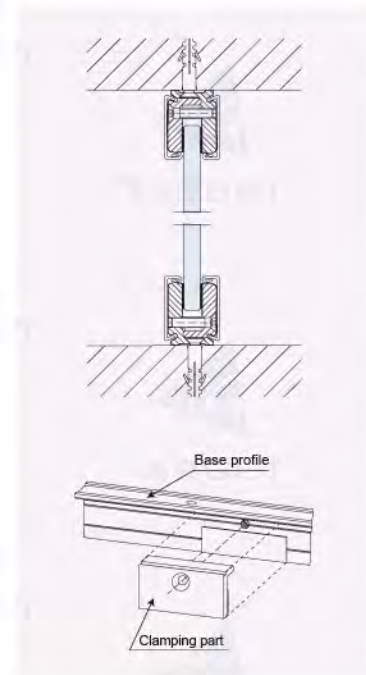
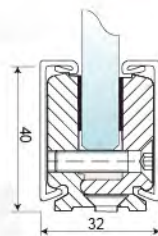

Patch Fitting

| Door Rails |

Art. No. APF-4000

Upper Rail



Art. No. APF-3000

Bottom Rails

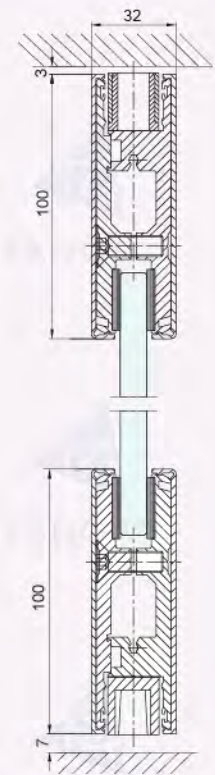
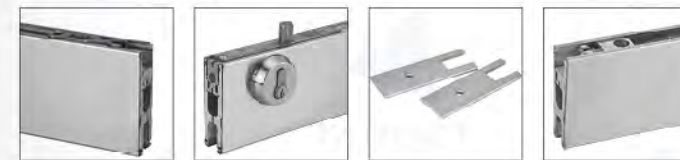

Material Aluminium & SUS304
Finish Polished / Satin
Glass Thickness 10-12mm



Patch Fitting

| Door Rails |

Art. No. APF-5000-1

Upper Rail



Art. No. APF-5000-2

Bottom Rails

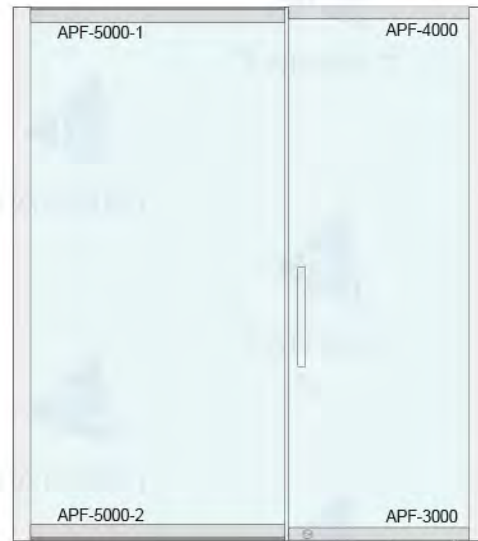
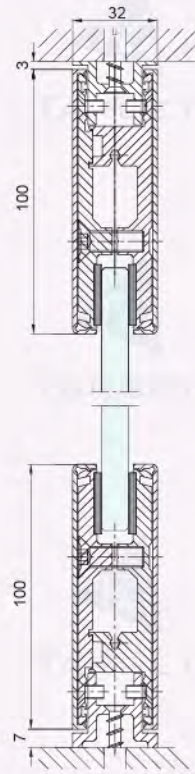

Material	Aluminium & SUS304
Finish	Polished / Satin
Glass Thickness	10-12mm

Floor Spring

Art. No. FSP-20

Floor Spring



LINE FIGURE

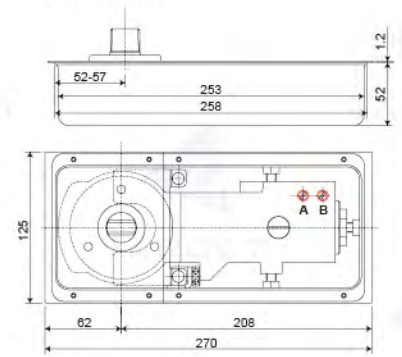

Technical Data



Closing force
Maximum door width
Maximum bearing weight
Opening angle

15Nm
 ≤950mm
 80kg
 90°

Valve Adjustment

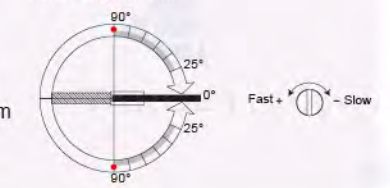

Art. No. FSP-65

Floor Spring



LINE FIGURE

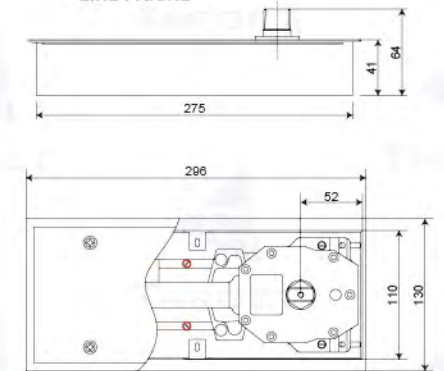

Technical Data



Closing force
Maximum door width
Maximum bearing weight
Opening angle

25Nm
 ≤1000mm
 100kg
 90°

Valve Adjustment

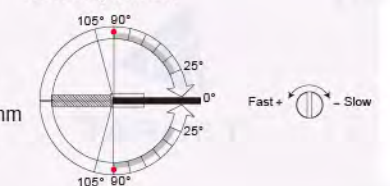

Floor Spring

Art. No. FSP-75
Floor Spring



LINE FIGURE

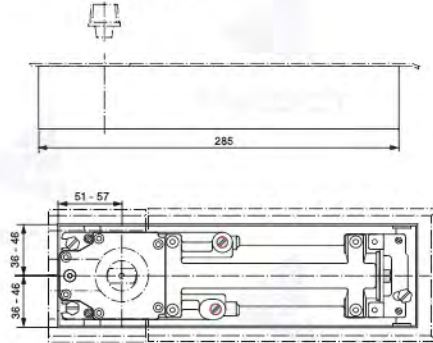

Technical Data



- Maximum Door Weight: 150kg
- Maximum Door Width: 1300mm
- Glass: Tempered Glass

Closing force
Maximum door width
Maximum bearing weight
Opening angle

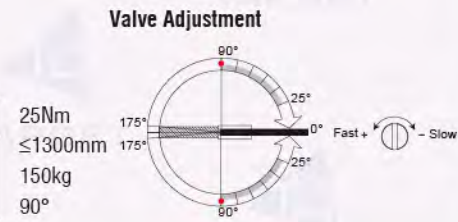

Art. No. FSP-80
Floor Spring



LINE FIGURE

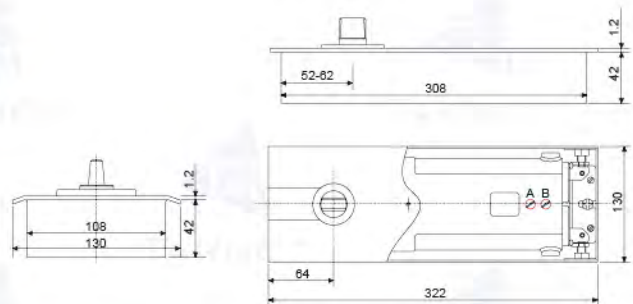

Technical Data



- Maximum Door Weight: 150kg
- Maximum Door Width: 1100mm
- Glass: Tempered Glass

Closing force
Maximum door width
Maximum bearing weight
Opening angle

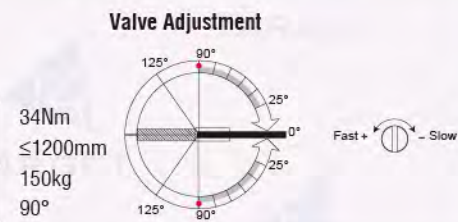

Floor Spring

Art. No. FSP-60
Floor Spring



LINE FIGURE

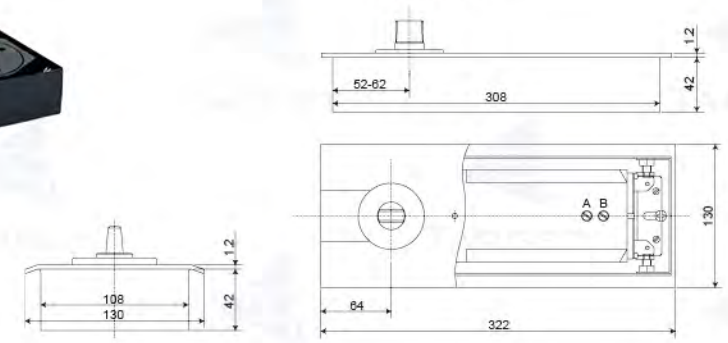

Technical Data



- Maximum Door Weight: 120kg
- Maximum Door Width: 1000mm
- Glass: Tempered Glass

Closing force
Maximum door width
Maximum bearing weight
Opening angle

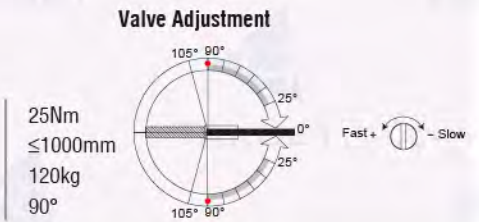

Art. No. FSP-90
Floor Spring



LINE FIGURE

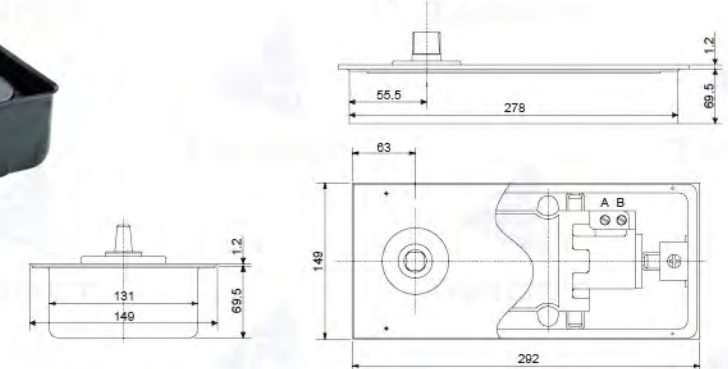

Technical Data



- Maximum Door Weight: 150kg
- Maximum Door Width: 1100mm
- Glass: Tempered Glass

Closing force
Maximum door width
Maximum bearing weight
Opening angle

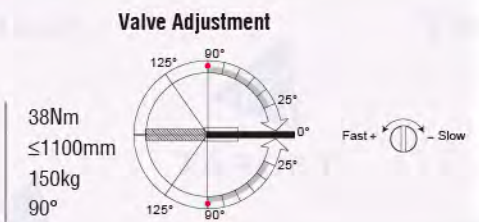



Glass Door Pull Handle

Pull Handles

Art. No. DH-207
Double "D" Pull Handle

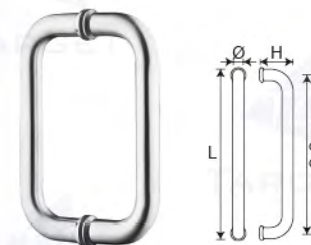

Art. No.	O	C/C	H
DH-207-A	19	152	60
DH-207-B	19	203	60

Material SUS304
Finish Polished / Satin / Matte Black / Gold

Art. No. DH-204
Double Pull Handle

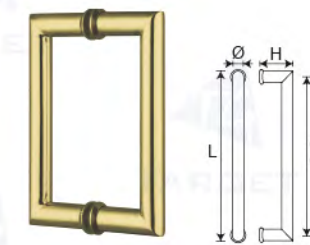

Art. No.	O	C/C	H
DH-204-A	19	152	60
DH-204-B	19	203	60

Material SUS304
Finish Polished / Satin / Matte Black / Gold

Art. No. DH-208
Double "D" Pull Handle



Art. No.	O	C/C	H
DH-208-A	19	152	60
DH-208-B	19	203	60

Material SUS304
Finish Polished / Satin / Matte Black / Gold

Art. No. DH-209
Double Pull Handle



Art. No.	O	C/C
DH-209-A	25	210

Material SUS304
Finish Polished / Satin / Matte Black / Gold

Pull Handles

Art. No. DH-861
Double Pull Handle

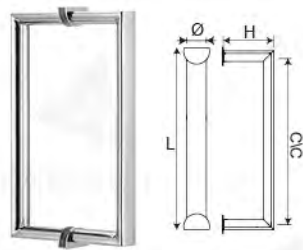

Art. No. DH-14S
Double Pull Handle

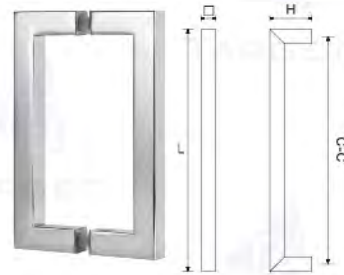

Art. No.	Ø	C/C	H
DH-861-A	12.5x24	152	60
DH-861-B	12.5x24	203	60
DH-861-C	12.5x24	457	60

Material SUS304
Finish Polished / Satin / Matte Black / Gold

Art. No.	□	C/C	H
DH-14S-A	16x16	152	55
DH-14S-B	19x19	152	55
DH-14S-C	19x19	203	60
DH-14S-D	19x19	457	60

Material SUS304
Finish Polished / Satin / Matte Black / Gold

Art. No. DH-01SR
"H" Shape Handle

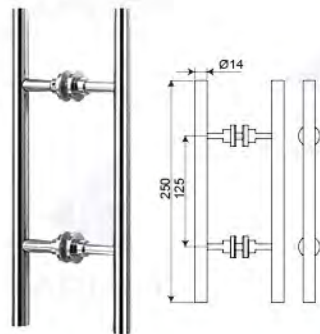

Art. No.	●	L	C/C	H
DH-01SR-A	14	250	125	55

Material SUS304
Finish Polished / Satin / Matte Black / Gold

Art. No. DH-01SQ
"H" Shape Handle

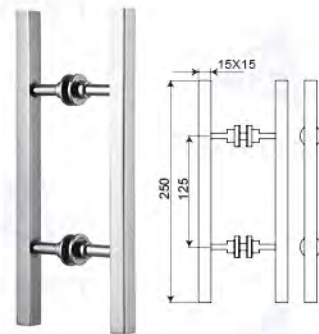

Art. No.	■	L	C/C	H
DH-01SQ-A	15x15	250	125	55

Material SUS304
Finish Polished / Satin / Matte Black / Gold

Pull Handles

Art. No. DH-01
"H" Shape Handle

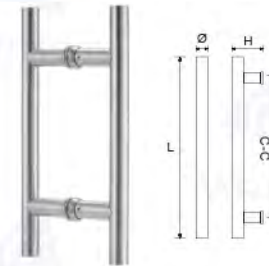

Art. No.	Ø	L	C/C	H
DH-01-A	19	254	152	60
DH-01-B	19	305	203	60

Material SUS304
Finish Polished / Satin / Matte Black / Gold

Art. No. DH-800ES
Single Pull Handle

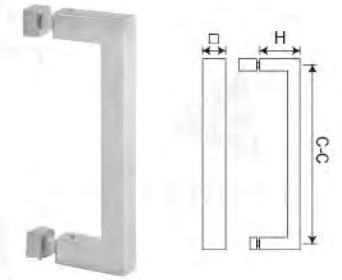

Art. No.	□	C/C	H
DH-800ES-A	16x16	152	55
DH-800ES-B	19x19	152	55
DH-800ES-C	19x19	203	60

Material SUS304
Finish Polished / Satin / Matte Black / Gold

Art. No. DH-204B
Square Corner Single-Sided Towel Bar

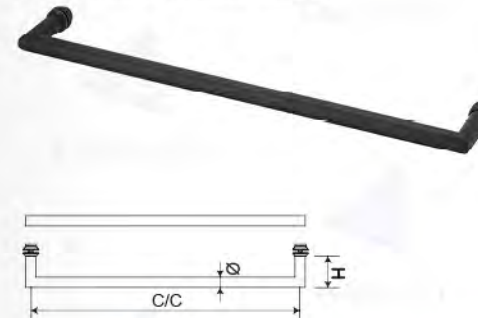

Art. No.	Ø	C/C	H
DH-204B-A	19	305	60
DH-204B-B	19	457	60
DH-204B-C	19	610	60

Material SUS304
Finish Polished / Satin / Matte Black / Gold

Art. No. DH-800NB
Single-Sided Towel Bar

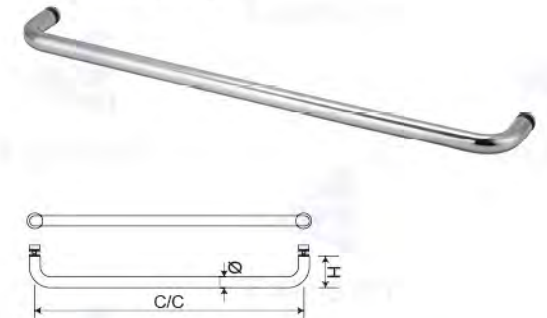

Art. No.	Ø	C/C	H
DH-800NB-A	19	305	60
DH-800NB-B	19	457	60
DH-800NB-C	19	610	60

Material SUS304
Finish Polished / Satin / Matte Black / Gold

Towel Bar

Art. No. DH-800B
Single-Sided Towel Bar

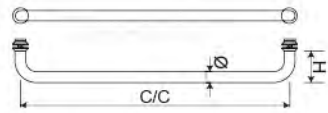

Art. No. DH-800E
Single-Sided Towel Bar

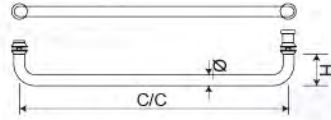

Art. No.	Ø	C/C	H
DH-800B-A	19	305	60
DH-800B-B	19	457	60
DH-800B-C	19	610	60

Material SUS304
Finish Polished / Satin / Matte Black / Gold

Art. No.	Ø	C/C	H
DH-800E-A	19	305	60
DH-800E-B	19	457	60
DH-800E-C	19	610	60

Material SUS304
Finish Polished / Satin / Matte Black / Gold

Art. No. DH-801C-S
Single-Sided Towel Bar

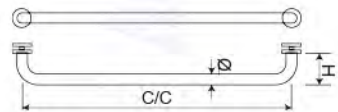

Art. No. DH-800S
Square corner single-Sided Towel Bar

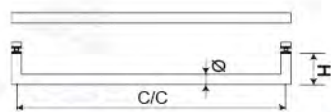

Art. No.	Ø	C/C	H
DH-801C-S-A	19	305	60
DH-801C-S-B	19	457	60
DH-801C-S-C	19	610	60

Material SUS304
Finish Polished / Satin / Matte Black / Gold

Art. No.	□	C/C	H
DH-800S-A	19x19	305	60
DH-800S-B	19x19	457	60
DH-800S-C	19x19	610	60

Material SUS304
Finish Polished / Satin / Matte Black / Gold

Pull Handles

Art. No. DH-801C
Pull Handle / Towel Bar Combination with Washers

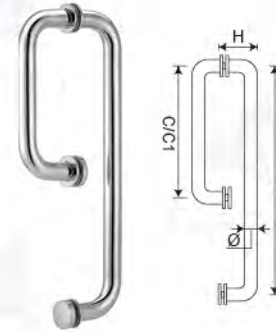

Art. No.	Ø	C/C1	C/C2	H
DH-801C-A	19	152	457	60
DH-801C-B	19	152	610	60
DH-801C-C	19	203	457	60
DH-801C-D	19	203	610	60

Material SUS304
Finish Polished / Satin / Matte Black / Gold

Art. No. DH-801
Pull Handle / Towel Bar Combination

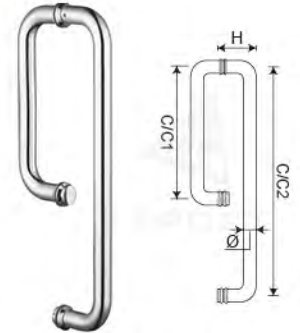

Art. No.	Ø	C/C1	C/C2	H
DH-801-A	19	152	457	60
DH-801-B	19	200	450	60
DH-801-C	19	275	425	60
DH-801-D	25	275	425	65

Material SUS304
Finish Polished / Satin / Matte Black / Gold

Art. No. DH-804
Pull Handle / Towel Bar Combination

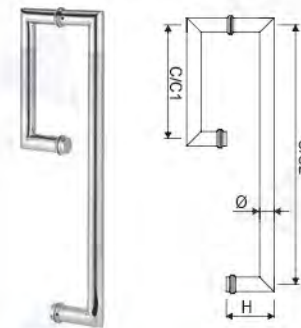

Art. No.	Ø	C/C1	C/C2	H
DH-804-A	19	152	457	60
DH-804-B	19	152	610	60
DH-804-C	19	203	457	60
DH-804-D	19	203	610	60

Material SUS304
Finish Polished / Satin / Matte Black / Gold

Art. No. DH-801S
Pull Handle / Towel Bar Combination

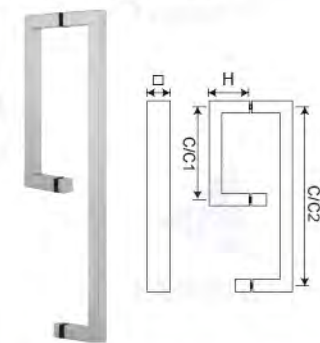

Art. No.	□	C/C1	C/C2	H
DH-801S-A	19x19	152	457	60
DH-801S-B	19x19	152	610	60
DH-801S-C	19x19	203	457	60
DH-801S-D	25x25	275	425	65

Material SUS304
Finish Polished / Satin / Matte Black / Gold

Glass Door Pull Handle

Art. No. DH-01
"H" Shape Handle

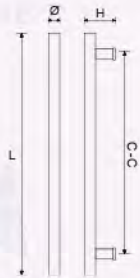

Material SUS304
Finish Polished / Satin / Matte Black / Gold

Art. No.	O	L	C/C	H
DH-01-A	25	450	300	65
DH-01-B	32	600	400	72
DH-01-C	32	1000	800	72
DH-01-D	32	1500	1000	72
DH-01-E	38	2000	1800	78

Art. No. DH-880
"H" Shape Handle With Knurling

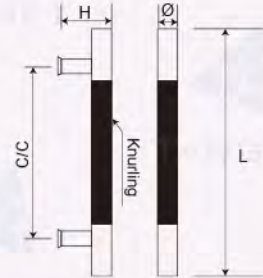

Material SUS304
Finish Polished / Satin / Matte Black / Gold

Art. No.	O	L	C/C	H
DH-880-A	25	450	300	65
DH-880-B	32	450	300	65
DH-880-C	32	600	400	72
DH-880-D	32	1000	800	72

Glass Door Pull Handle

Art. No. DH-45-2
Door Handle

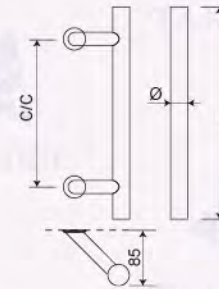

Material SUS304
Finish Polished / Satin / Matte Black / Gold

Art. No.	O	L	C/C	H
DH-45-2-A	32	610	305	85
DH-45-2-B	32	914	610	85
DH-45-2-C	32	1219	914	85
DH-45-2-D	32	1524	1219	85
DH-45-2-E	32	1829	1524	85

Art. No. DH-45-3
Door Handle

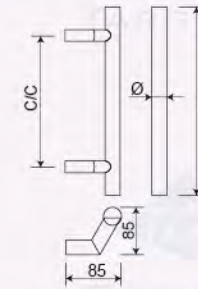

Material SUS304
Finish Polished / Satin / Matte Black / Gold

Art. No.	O	L	C/C	H
DH-45-3-A	32	610	305	85
DH-45-3-B	32	914	610	85
DH-45-3-C	32	1219	914	85
DH-45-3-D	32	1524	1219	85
DH-45-3-E	32	1829	1524	85

Glass Door Pull Handle

Art. No. DH-02
"H" Shape Handle

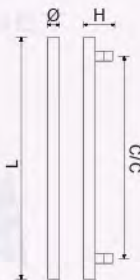

Material SUS304
Finish Polished / Satin / Matte Black / Gold

Art. No.	O	L	C/C	H
DH-02-A	32	600	400	65
DH-02-B	32	800	600	65

Art. No. DH-03
"H" Shape Handle

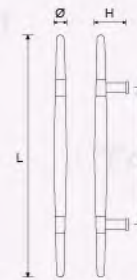

Material SUS304
Finish Polished / Satin / Matte Black / Gold

Art. No.	O	L	C/C	H
DH-03-A	32	600	300	72
DH-03-B	38	800	400	80

Glass Door Pull Handle

Art. No. DH-06
"S" Shape Handle



Material SUS304
Finish Polished / Satin / Matte Black / Gold

Art. No.	O	L	C/C	H
DH-06-A	25	500	300	65
DH-06-B	32	600	400	72

Art. No. DH-14B
Door Handle



Material SUS304
Finish Polished / Satin / Matte Black / Gold

Art. No.	O	L	C/C	B
DH-14B-A	32	800	600	100
DH-14B-B	32	1000	800	100

Glass Door Pull Handle

Art. No. DH-15
"H" Shape Handle



Material | SUS304
Finish | Polished / Satin / Matte Black / Gold

Art. No.	□	L	C/C	H
DH-15-A	25x25	475	275	65
DH-15-B	25x25	600	425	65
DH-15-C	32x32	914	610	72
DH-15-D	32x32	1219	914	72
DH-15-E	32x32	1524	1219	72

Art. No. DH-15F
"H" Shape Handle

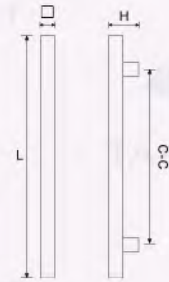

Material | SUS304
Finish | Polished / Satin / Matte Black / Gold

Art. No.	□	L	C/C	H
DH-15F-A	50x25	475	450	65
DH-15F-B	50x25	600	575	65

Glass Door Pull Handle

Art. No. DH-14S
Double Pull Handle



material | SUS304
Finish | Polished / Satin / Matte Black / Gold

Art. No.	□	L	C/C	H
DH-14S-A	25x25	475	450	65
DH-14S-B	25x25	600	575	65

Art. No. DH-14
Double Pull Handle



material | SUS304
Finish | Polished / Satin / Matte Black / Gold

Art. No.	□	L	C/C	H
DH-14-A	50x25	475	450	65
DH-14-B	50x25	600	575	65
DH-14-C	38x25	475	450	78
DH-14-D	38x25	600	575	78

Glass Door Pull Handle

Art. No. DH-07
Door Handle

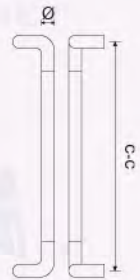

Material | SUS304
Finish | Polished / Satin / Matte Black / Gold

Art. No.	O	C/C
DH-07-A	32	425
DH-07-B	38	562

Art. No. DH-821
Door Handle

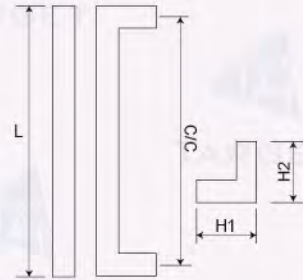

Material | SUS304
Finish | Polished / Satin / Matte Black / Gold

Art. No.	C/C	L	C/C
DH-821-A	25x25	330	305
DH-821-B	25x25	625	600
DH-821-C	38x25	457	419
DH-821-D	38x25	610	572
DH-821-E	38x25	914	876
DH-821-F	38x25	1219	1181

Glass Door Pull Handle

Art. No. DH-207
Door Handle

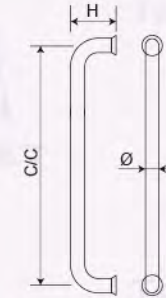

Material | SUS304
Finish | Polished / Satin / Matte Black / Gold

Art. No.	O	C/C	H
DH-207-A	25	450	65
DH-207-B	25	500	65
DH-207-C	25	600	65

Art. No. DH-08
Double Pull Handle

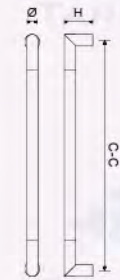

Material | SUS304
Finish | Polished / Satin / Matte Black / Gold

Art. No.	O	C/C	H
DH-08-A	32	418	72
DH-08-B	32	568	72

Glass Door Pull Handle

Art. No. DH-804
Towel Bar Combination

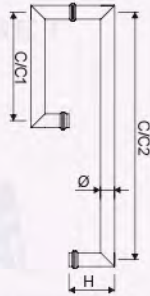

Material SUS304
Finish Polished / Satin / Matte Black / Gold

Art. No.	Ø	C/C 1	C/C 2	H
DH-804-A	25	200	450	65

Art. No. DH-801H
Towel Bar Combination

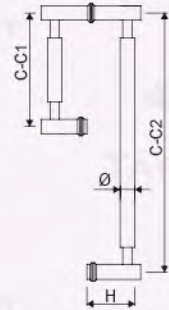

Material SUS304
Finish Polished / Satin / Matte Black / Gold

Art. No.	Ø	C/C 1	C/C 2	H
DH-801H-A	25	250	450	65

Glass Door Pull Handle

Art. No. DH-15B
Door Handle

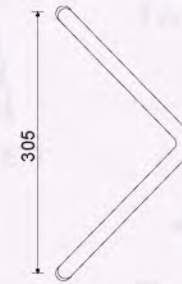

Material SUS304
Finish Polished / Satin / Matte Black / Gold

Art. No.	Ø	C/C
DH-15B-A	32	305

Art. No. DH-16B
Door Handle



Material SUS304
Finish Polished / Satin / Matte Black / Gold

Art. No.	Ø	C/C
DH-16B-A	32	305

Glass Door Pull Handle

Art. No. DH-100W
Door Handle

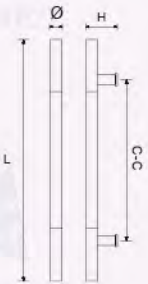

Material SUS304
Finish Polished / Satin / Matte Black / Gold

Art. No.	Ø	L	C/C	H
DH-100W-A	33	450	350	73
DH-100W-B	39	800	500	79
DH-100W-C	39	1200	800	79

Art. No. DH-99W
Door Handle

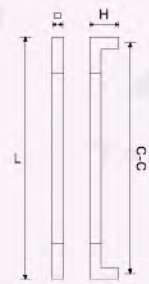

Material SUS304
Finish Polished / Satin / Matte Black / Gold

Art. No.	□	L	C/C	H
DH-99W-A	30x30	500	470	70
DH-99W-B	38x38	800	762	78

Pull Handle with Lock

Art. No. OF-H-1
Pull Handle with Lock

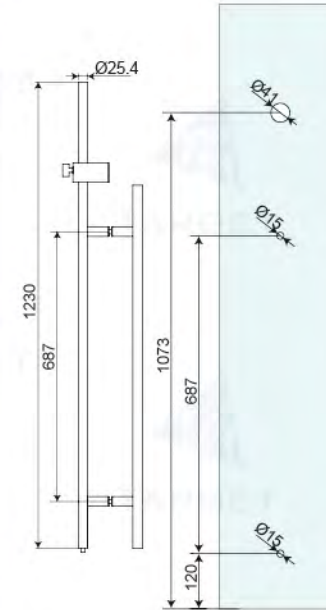

Art. No. DP002

8-12mm Tempered Glass

Material SUS304
Finish Polished / Satin / Matte Black / Gold

Art. No. OF-H-2
Pull Handle with Lock

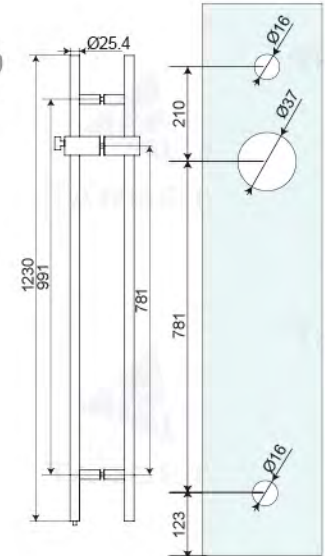
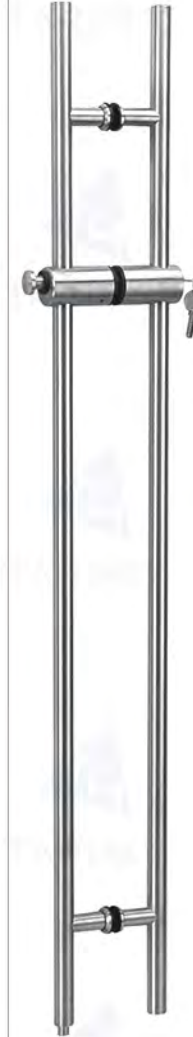

Art. No. DP002

8-12mm Tempered Glass

Material SUS304
Finish Polished / Satin / Matte Black / Gold

Pull Handle with Lock

Art. No. OF-H-4

Pull Handle with Lock

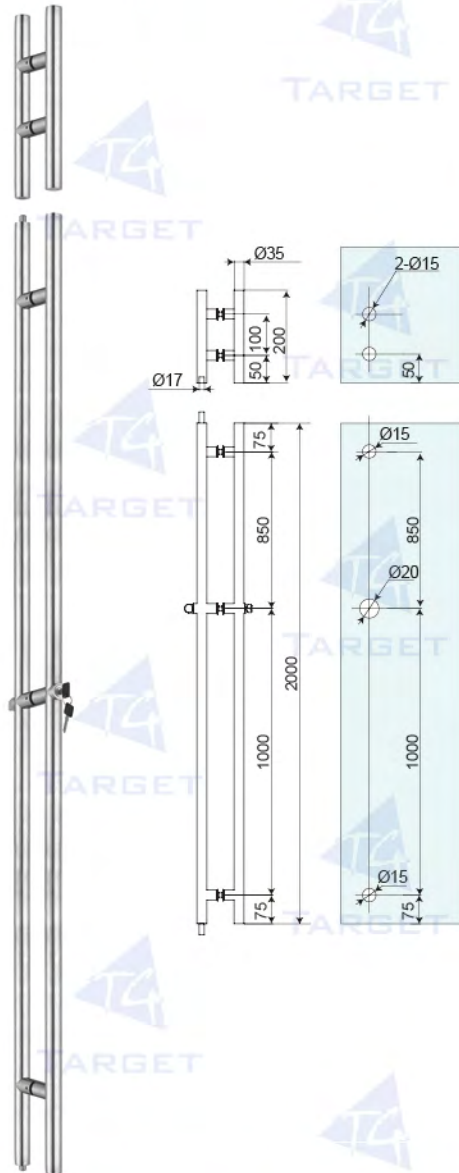

Art. No. OF-H-5

Pull Handle with Lock

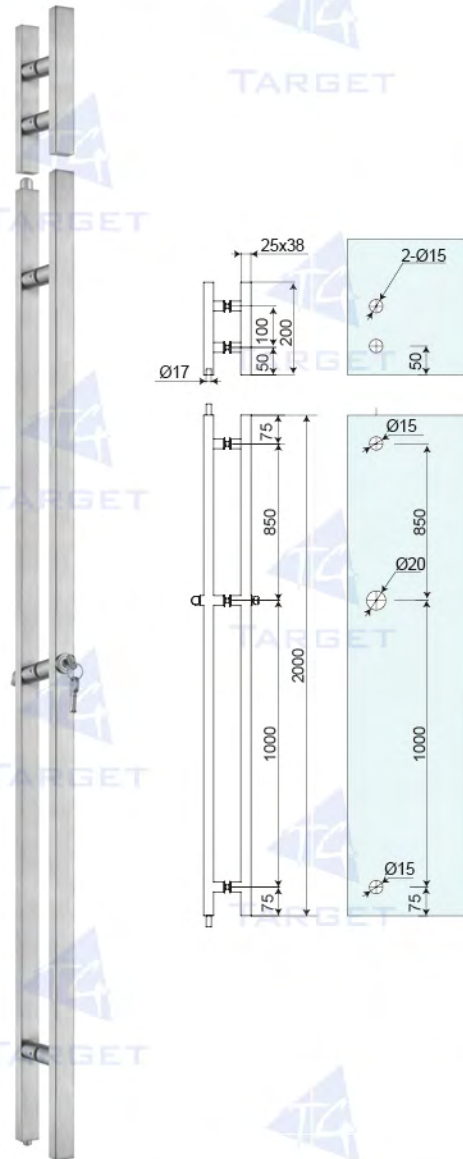

8-12mm Tempered Glass

Material | SUS304

Finish | Polished / Satin / Matte Black / Gold

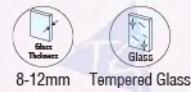

8-12mm Tempered Glass

Material | SUS304

Finish | Polished / Satin / Matte Black / Gold

Lever Handle



Lever Handle



Art. No. DLH-T01
Lever Handle (Hollow)

Material
SUS304
Finished
Polished / Satin / Powder Coating / PVD Coated

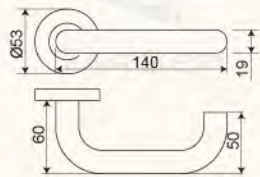

Art. No. DLH-T02
Lever Handle (Hollow)

Material
SUS304
Finished
Polished / Satin / Powder Coating / PVD Coated

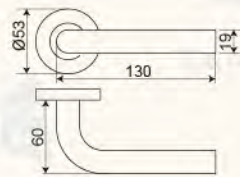

Art. No. DLH-T03
Lever Handle (Hollow)

Material
SUS304
Finished
Polished / Satin / Powder Coating / PVD Coated

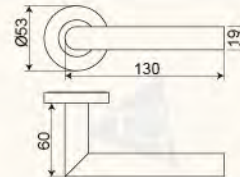

Art. No. DLH-T06
Lever Handle (Hollow)

Material
SUS304
Finished
Polished / Satin / Powder Coating / PVD Coated

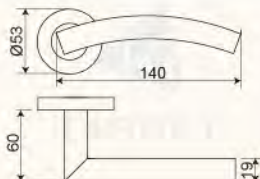

Art. No. DLH-T19
Lever Handle (Hollow)

Material
SUS304
Finished
Polished / Satin / Powder Coating / PVD Coated

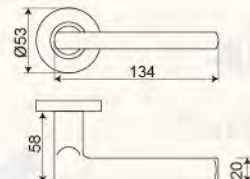

Art. No. DLH-T23
Lever Handle (Hollow)

Material
SUS304
Finished
Polished / Satin / Powder Coating / PVD Coated

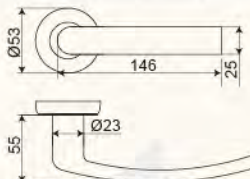

Lever Handle New



Art. No. DLH-F01
Lever Handle (Hollow)

Material
SUS304
Finished
Polished / Satin / Powder Coating / PVD Coated

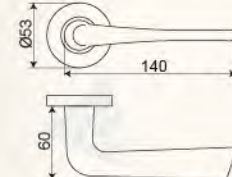

Art. No. DLH-F02
Lever Handle (Hollow)

Material
SUS304
Finished
Polished / Satin / Powder Coating / PVD Coated

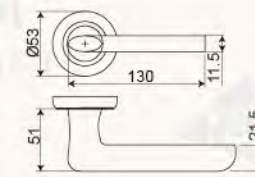

Art. No. DLH-F03
Lever Handle (Hollow)

Material
SUS304
Finished
Polished / Satin / Powder Coating / PVD Coated

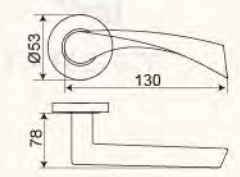

Art. No. DLH-F05
Lever Handle (Hollow)

Material
SUS304
Finished
Polished / Satin / Powder Coating / PVD Coated

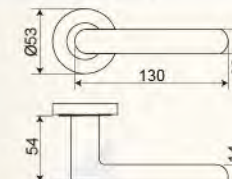

Art. No. DLH-F06
Lever Handle (Hollow)

Material
SUS304
Finished
Polished / Satin / Powder Coating / PVD Coated

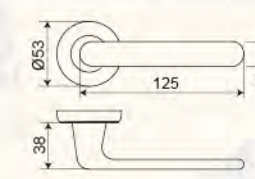

Art. No. DLH-F07
Lever Handle (Hollow)

Material
SUS304
Finished
Polished / Satin / Powder Coating / PVD Coated

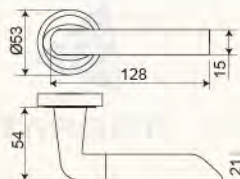

Lever Handle



Art. No. DLH-Q01
Lever Handle (Hollow)

Material
SUS304
Finished
Polished / Satin / Powder Coating / PVD Coated

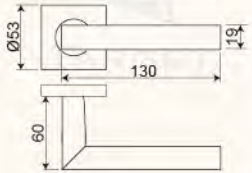

Art. No. DLH-Q02
Lever Handle (Hollow)

Material
SUS304
Finished
Polished / Satin / Powder Coating / PVD Coated

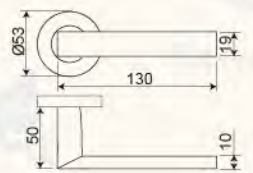

Art. No. DLH-S04
Lever Handle (Hollow)

Material
SUS304
Finished
Polished / Satin / Powder Coating / PVD Coated

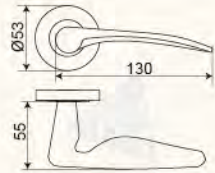

Art. No. DLH-S07
Lever Handle (Solid)

Material
SUS304
Finished
Polished / Satin / Powder Coating / PVD Coated

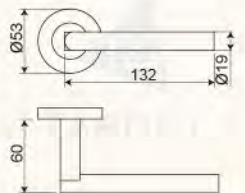

Art. No. DLH-S10
Lever Handle (Solid)

Material
SUS304
Finished
Polished / Satin / Powder Coating / PVD Coated

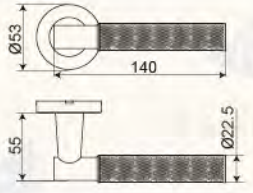

Art. No. DLH-S11
Lever Handle (Solid)

Material
SUS304
Finished
Polished / Satin / Powder Coating / PVD Coated

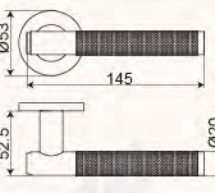

Door Stopper



Art. No. DSP-10S
Door Stopper

Material
SUS304
Finish
Polished / Satin

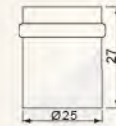

Art. No. DSP-10
Door Stopper

Material
SUS304
Finish
Polished / Satin



Art. No. DSP-03
Door Stopper

Material
SUS304
Finish
Polished / Satin

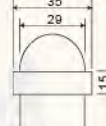

Art. No. DSP-09
Door Stopper

Material
SUS304
Finish
Polished / Satin

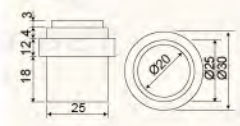

Art. No. DSP-08
Door Stopper

Material
SUS304
Finish
Polished / Satin

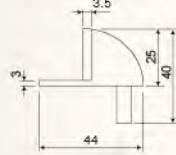

Art. No. DSP-21
Magnetic Door Stopper

Material
Zinc Alloy
Finish
Chrome / Satin Nickel

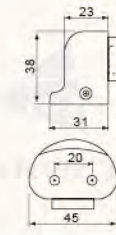

Art. No. DSP-30
Magnetic Door Stopper

Material
SUS304
Finish
Polished / Satin



Art. No. DSP-36
Door Stopper

Material
SUS304
Finish
Polished / Satin

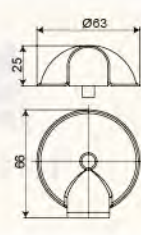

Door Stopper



Art. No. DSP-06
Magnetic Door Stopper

Material
SUS304
Finish
Polished / Satin

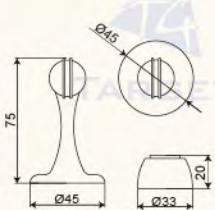

Art. No. DSP-24
Door Stopper For Wall Fixing

Material
SUS304
Finish
Polished / Satin

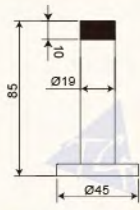

Art. No. DSP-28
Door holder

Material
SUS304
Finish
Polished / Satin

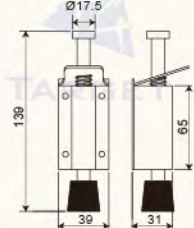

Art. No. DSP-31
Door Stopper

Material
SUS304
Finish
Polished / Satin

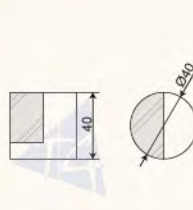

Art. No. DSP-32
Magnetic Door Stopper

Material
Zinc Alloy
Finish
Chrome / Satin Nickel

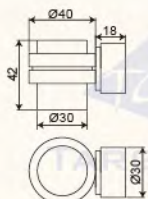

Art. No. DSP-33
Magnetic Door Stopper

Material
SUS304
Finish
Polished / Satin

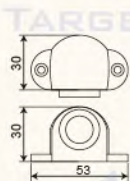

Art. No. DSP-34
Door Stopper

Material
SUS304
Finish
Polished / Satin

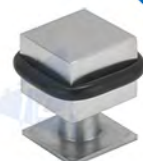
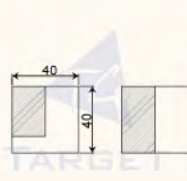

Art. No. DSP-35
Door Stopper

Material
SUS304
Finish
Polished / Satin

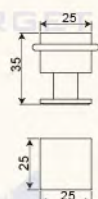

Spider Series

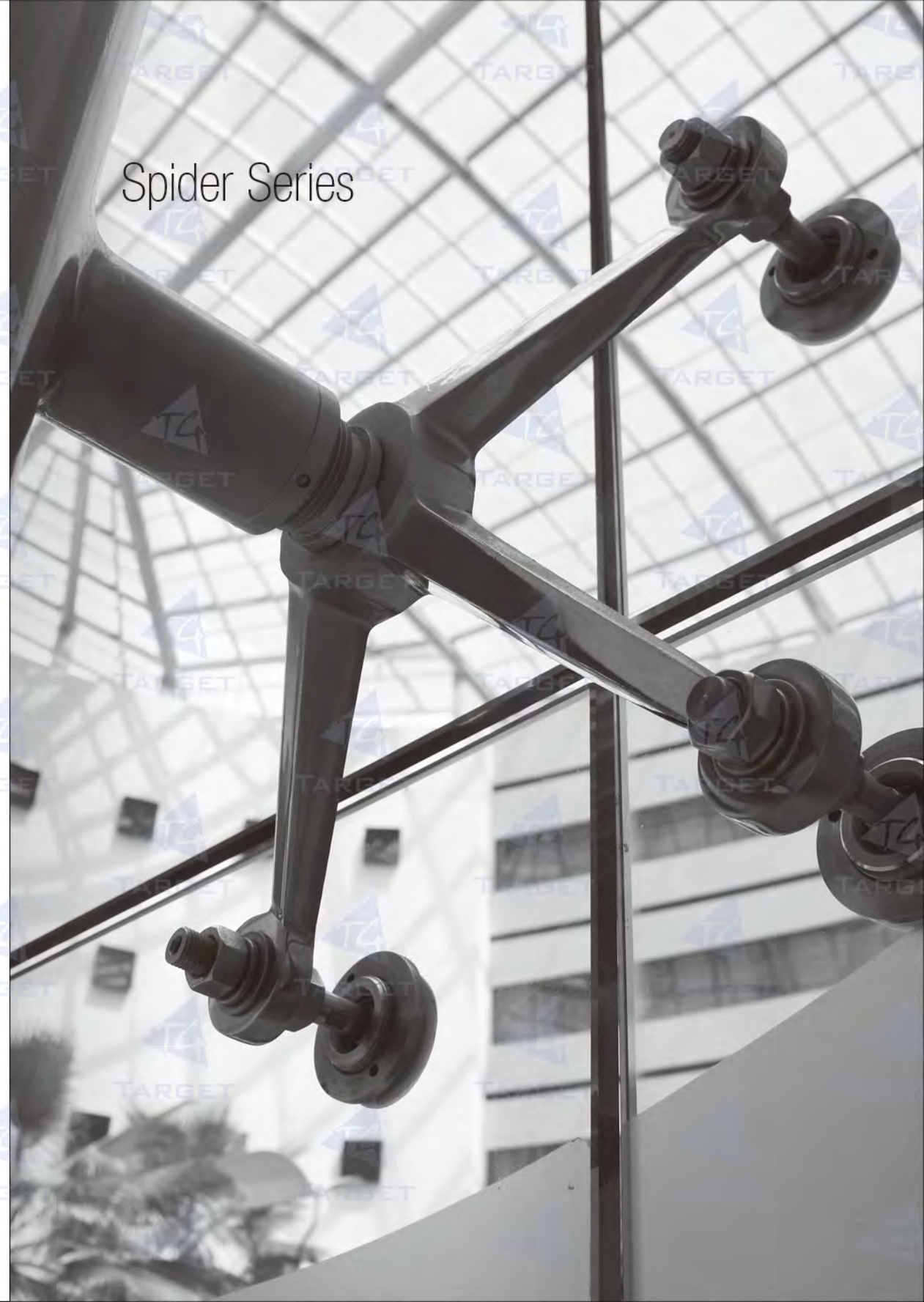

Spider 250 Series



Art. No. TG250-4
4 Arms Spider Fittings

Material
SUS304 / SUS316
Finish
Polished / Satin

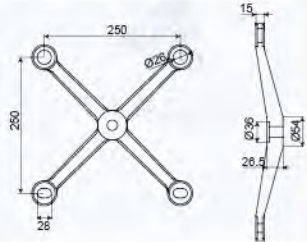

Art. No. TG250-3
3 Arms Spider Fittings

Material
SUS304 / SUS316
Finish
Polished / Satin

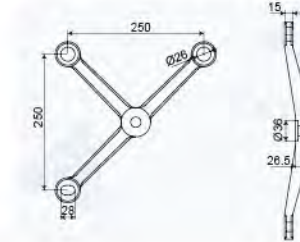

Art. No. TG250-2-180
180° 2 Arms Spider Fittings

Material
SUS304 / SUS316
Finish
Polished / Satin

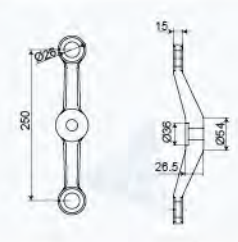

Art. No. TG250-2-90
90° 2 Arms Spider Fittings

Material
SUS304 / SUS316
Finish
Polished / Satin

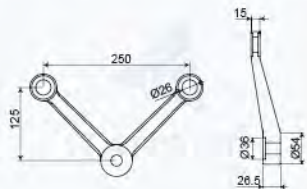

Art. No. TG250-1-180
180° 1 Arm Spider Fittings

Material
SUS304 / SUS316
Finish
Polished / Satin

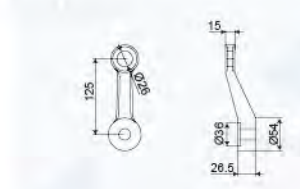

Art. No. TG250-1-90
90° 1 Arm Spider Fittings

Material
SUS304 / SUS316
Finish
Polished / Satin

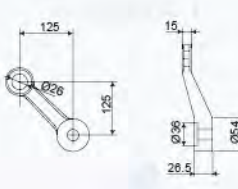

Spider 250 Series



Art. No. TG250-4R
4 Arms Spider Fittings

Material
SUS304 / SUS316
Finish
Polished / Satin

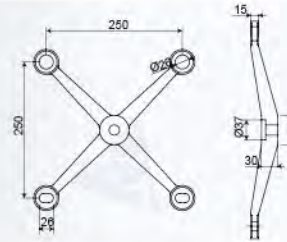

Art. No. TG250-3R
3 Arms Spider Fittings

Material
SUS304 / SUS316
Finish
Polished / Satin

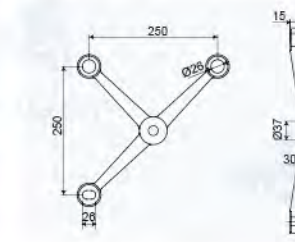

Art. No. TG250-2-180R
180° 2 Arms Spider Fittings

Material
SUS304 / SUS316
Finish
Polished / Satin

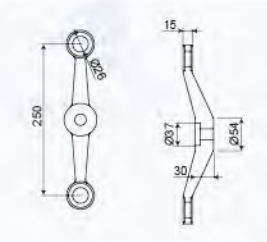

Art. No. TG250-2-90R
90° 2 Arms Spider Fittings

Material
SUS304 / SUS316
Finish
Polished / Satin

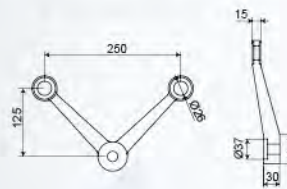

Art. No. TG250-1-180R
180° 1 Arm Spider Fittings

Material
SUS304 / SUS316
Finish
Polished / Satin

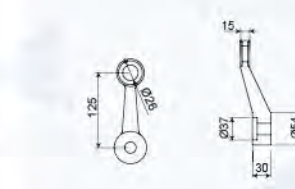

Art. No. TG250-1-90R
90° 1 Arm Spider Fittings

Material
SUS304 / SUS316
Finish
Polished / Satin

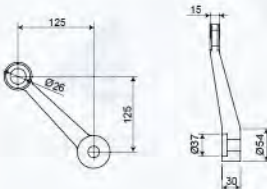

Spider 204 Series



Art. No. TG204-4
4 Arms Spider Fittings

Material
SUS304 / SUS316
Finish
Polished / Satin



Art. No. TG204-3
3 Arms Spider Fittings

Material
SUS304 / SUS316
Finish
Polished / Satin



Art. No. TG204-2-180
180° 2 Arms Spider Fittings

Material
SUS304 / SUS316
Finish
Polished / Satin

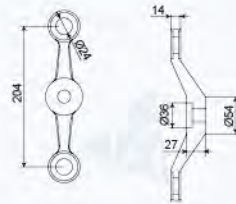
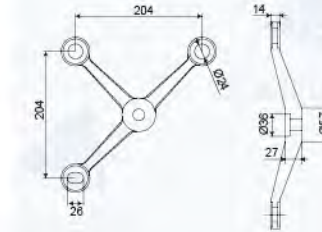
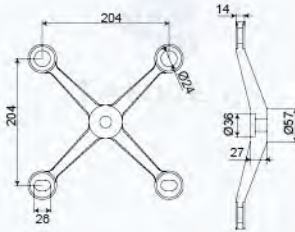

Art. No. TG204-2-90
90° 2 Arms Spider Fittings

Material
SUS304 / SUS316
Finish
Polished / Satin



Art. No. TG204-1-180
180° 1 Arm Spider Fittings

Material
SUS304 / SUS316
Finish
Polished / Satin



Art. No. TG204-1-90
90° 1 Arm Spider Fittings

Material
SUS304 / SUS316
Finish
Polished / Satin

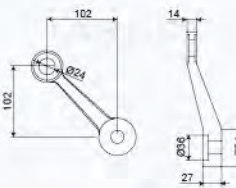
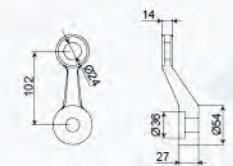
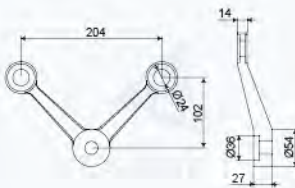

Spider 150 Series



Art. No. TG150-4
4 Arms Spider Fittings

Material
SUS304 / SUS316
Finish
Polished / Satin



Art. No. TG150-3
3 Arms Spider Fittings

Material
SUS304 / SUS316
Finish
Polished / Satin



Art. No. TG150-2-180
180° 2 Arms Spider Fittings

Material
SUS304 / SUS316
Finish
Polished / Satin

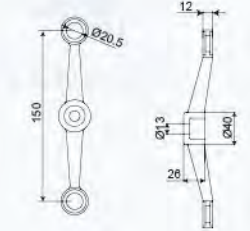
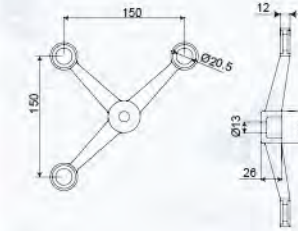
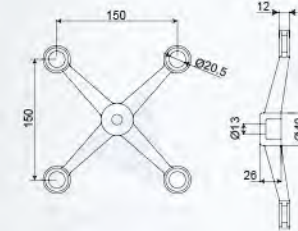

Art. No. TG150-2-90
90° 2 Arms Spider Fittings

Material
SUS304 / SUS316
Finish
Polished / Satin



Art. No. TG150-1-180
180° 1 Arm Spider Fittings

Material
SUS304 / SUS316
Finish
Polished / Satin



Art. No. TG150-1-90
90° 1 Arm Spider Fittings

Material
SUS304 / SUS316
Finish
Polished / Satin

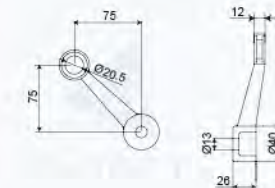
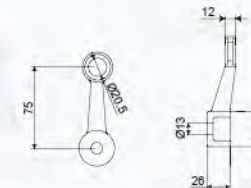
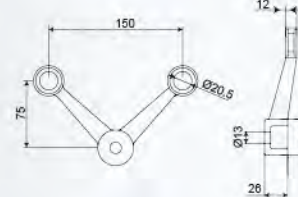

Spider S200/S210 Series



Art. No. TGS200-4
4 Arms Spider Fittings

Material
SUS304 / SUS316
Finish
Polished / Satin



Art. No. TGS200-2-180
180° 2 Arms Spider Fittings

Material
SUS304 / SUS316
Finish
Polished / Satin



Art. No. TGS200-1-90
180° 1 Arm Spider Fittings

Material
SUS304 / SUS316
Finish
Polished / Satin

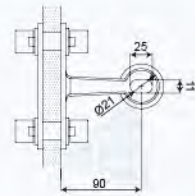
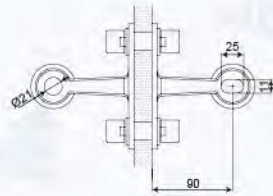
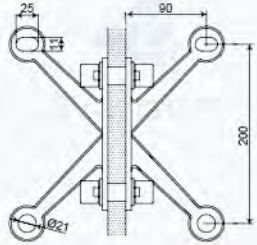

Art. No. TGS200-2-90
90° 2 Arms Spider Fittings

Material
SUS304 / SUS316
Finish
Polished / Satin



Art. No. TGS210-4
4 Arms Spider Fittings

Material
SUS304 / SUS316
Finish
Polished / Satin



Art. No. TGS210-2-180
180° 2 Arms Spider Fittings

Material
SUS304 / SUS316
Finish
Polished / Satin

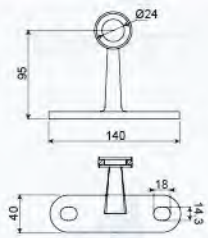
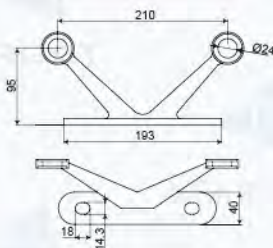
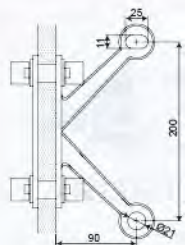

Routel Series



Art. No. TG-T01S
Glass ≤ 15mm

Material
SUS304 / SUS316
Finish
Polished / Satin

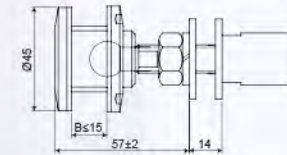

Art. No. TG-T01
Glass ≤ 15mm

Material
SUS304 / SUS316
Finish
Polished / Satin

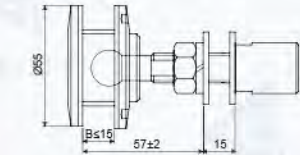

Art. No. TG-T01B
Glass ≤ 22mm

Material
SUS304 / SUS316
Finish
Polished / Satin

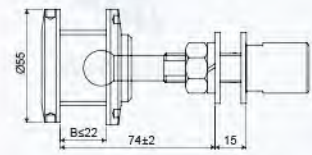

Art. No. TG-T03
Glass ≤ 15mm

Material
SUS304 / SUS316
Finish
Polished / Satin

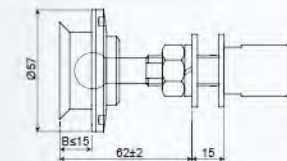

Art. No. TG-T03B
Glass ≤ 22mm

Material
SUS304 / SUS316
Finish
Polished / Satin

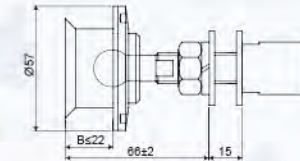

Art. No. TG-T04
Glass ≤ 10mm

Material
SUS304 / SUS316
Finish
Polished / Satin

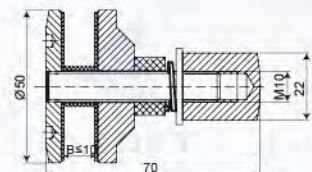

Connector Series



Art. No. TG-S01

Connector

Material

SUS304 & Steel

Finish

Polished / Satin

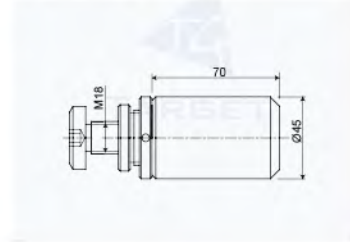

Art. No. TG-S02

Connector

Material

SUS304 & Steel

Finish

Polished / Satin

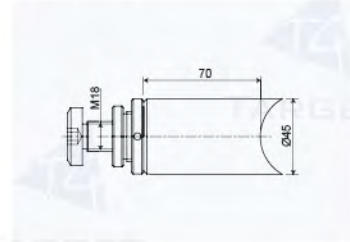

Art. No. TG-S05

Connector

Material

SUS304 & Steel

Finish

Polished / Satin

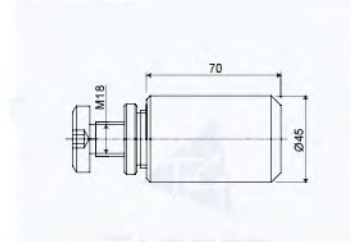

Tools

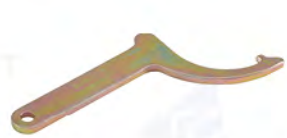

Art. No. T1



Art. No. T2



Art. No. T3

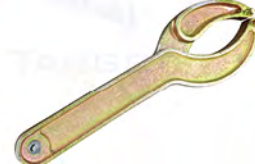

Art. No. T4



江门市泰景玻璃五金厂有限公司

地址：广东省江门市蓬江区潮连工业园富康五街 16 号，529090

TARGET HARDWARE FACTORY

Add: No.16, Fukang 5th Street, Chaolian Industry, Pengjiang Area, Jiangmen City, Guangdong Province, China.

Tel:0086-750-3729828 Fax:0086-750-3729818

www.hardware.hk.cn

www.target-hardware.com

E-mail: info@hardware.hk.cn